



Main

Range of product	Phaseo
Product or component type	Power supply
Power supply type	Regulated switch mode
Input voltage	100...370 V DC 120...230 V AC single phase , terminal(s): N-L1 120...230 V AC phase to phase , terminal(s): L1-L2
Output voltage	24 V DC
Rated power in W	85 W
Input protection type	Integrated fuse (not interchangeable)
Power supply output current	3.5 A
Output protection type	Thermal Against overvoltage Against short-circuits , protection technology: auto- matic reset Against overload , protection technology: 33 V
Ambient air temperature for operation	-20...45 °C without derating 45...60 °C with rated power derating 1.4 W per °C

Complementary

Input voltage limits	90...264 V
Network frequency	47...63 Hz
Inrush current	<= 27 A
Cos phi	> 0.65
Efficiency	86...90 %
Output voltage limits	96...114 % adjustable
Power dissipation in W	11 W 15 W
Current consumption	0.8 A at 230 V 1.4 A at 120 V
Line and load regulation	+/- 1 %
Residual ripple	<= 100 mV
Holding time	>= 20 ms at 120 V >= 70 ms at 230 V
Permissible temporary current boost	1.7 x I _n for 30 seconds
Connections - terminals	Removable screw terminal block for input connection , connection capacity: 2 x 0.2...2 x 2.5 mm ² AWG gauge24...12 Removable screw terminal block for input ground connection , connection capacity: 1 x 0.2...1 x 2.5 mm ² AWG gauge24...12 Removable screw terminal block for output connection , connection capacity: 4 x 0.5...2 x 2.5 mm ² AWG gauge24...12 Removable screw terminal block for diagnostic relay , connection capacity: 2 x 0.2...2 x 2.5 mm ² AWG gauge24...12
Marking	CE
Mounting support	35 x 15 mm symmetrical DIN rail 35 x 7.5 mm symmetrical DIN rail
Operating position	Vertical
Output coupling	Parallel Series

The information provided in this documentation contains general descriptions and/or technical characteristics of the performance of the products contained herein. This documentation is not intended as a substitute for and is not to be used for determining suitability or reliability of these products for specific user applications. It is the duty of any such user or integrator to perform the appropriate and complete risk analysis, evaluation and testing of the products with respect to the relevant specific application or use thereof. Neither Schneider Electric Industries SAS nor any of its affiliates or subsidiaries shall be responsible or liable for misuse of the information contained herein.

Name of test	Electrostatic discharges conforming to EN/IEC 61000-4-2 Induced electromagnetic field conforming to EN/IEC 61000-4-6 Magnetic field conforming to EN 61000-4-8 Primary outage conforming to IEC 61000-4-11 Radiated electromagnetic field conforming to EN/IEC 61000-4-3 Radiated emissions conforming to EN 55011 class A Rapid transient conforming to IEC 61000-4-4 Surge conforming to EN/IEC 61000-4-5 Conducted emissions on the power line conforming to EN 55011 class A
Status LED	1 LED green for output voltage (> 21.6 V) 1 LED red for overload
Product weight	0.4 kg

Environment

Product certifications	CSA C22-2 No 14 CULus 508
Environmental characteristic	EMC conforming to EN 50081-1 EMC conforming to EN 50082-2 EMC conforming to EN/IEC 61000-6-2 Safety conforming to EN/IEC 60950 Safety conforming to SELV
IP degree of protection	IP20 conforming to EN/IEC 60529
Ambient air temperature for storage	-25...80 °C
Relative humidity	0...90 % during operation 0...95 % in storage
Class of protection against electric shock	Class I conforming to VDE 0106-1
Dielectric strength	1500 V between input and ground 3000 V between input and output 500 V between output and ground

ABL4RSM240.../4RSM24100/4WSR24... Power Supplies

Dimensions

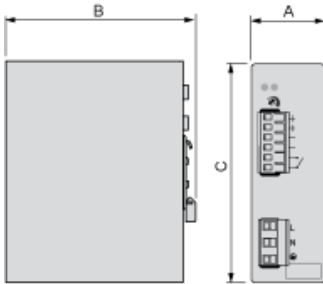

mm/inch	A	B	C
ABL4RSM24035	39/1.53	128/5.04	115/4.53
ABL4RSM24050			
ABL4RSM24100	63.5/2.49	140/5.51	118/4.65
ABL4RSM24200			
ABL4WSR24200	80/3.15	139/5.47	127/5.0
ABL4WSR24300			
ABL4WSR24400			

ABL4RSM240.../4RSM24100/4WSR24...

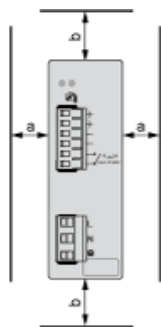

Clearance



mm/inch	a	b
ABL4RSM24035	10/0.39	50/1.97
ABL4RSM24050	10/0.39	50/1.97
ABL4RSM24100	20/0.79	100/3.94
ABL4RSM24200	20/0.79	100/3.94
ABL4WSR24200	10/0.39	50/1.97
ABL4WSR24300	10/0.39	50/1.97
ABL4WSR24400	10/0.39	50/1.97

Wiring Requirements

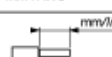
Cable Types and Wire Sizes

	ABL4RSM24035 ABL4RSM24050 ABL4RSM24100	ABL4RSM24200 ABL4WSR24●●●
		
mm ² /AWG	0,2...2,5 / 24...12	0,05...6 / 24...10
 mm/in	7 / 0.27	8 / 0.31
 Nm/lb-in	0,8 / 7.0	1,1 / 9.0

Input Voltage

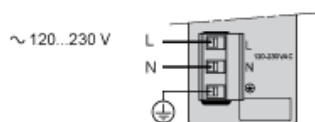

Outputs Connected in Parallel

Paralleling

- Use maximum of 2 power supplies with the same reference.
- For correct current share ($\pm 20\%$) between devices in parallel, adjust VOUT ± 20 mV applying a load $> P_{NOM} \times 0.2$ to all ABL4 before connecting them in parallel.

SELV: Safety Extra Low Voltage

Safety Extra Low Voltage in accordance to IEC/EN 60950 and IEC/EN 50178 standards.

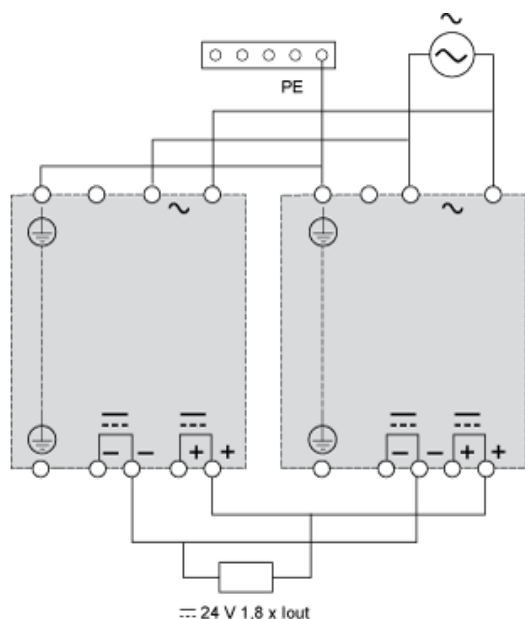

PELV: Protection Extra Low Voltage

