



Up to Category 4, EN 954-1 PNOZ XV2



Safety relay for monitoring E-STOP pushbuttons and safety gates.

Approvals

PNOZ XV2	
	◆
	◆
	◆

Unit features

- ▶ Positive-guided relay outputs:
 - 2 safety contacts (N/O), instantaneous
 - 2 safety contacts (N/O), delay-on de-energisation
- ▶ Connection options for:
 - E-STOP pushbutton
 - Safety gate limit switch
 - Reset button
- ▶ LED indicator for:
 - Switch status channel 1/2
 - Supply voltage
 - Reset circuit
- ▶ Delay-on de-energisation, fixed or adjustable
- ▶ Delay time can be cancelled via reset button
- ▶ See order reference for unit types

The max. category the safety contacts can achieve in accordance with EN 954-1 is stated in the technical details.

Safety features

The relay meets the following safety requirements:

- ▶ The circuit is redundant with built-in self-monitoring.
- ▶ The safety function remains effective in the case of a component failure.
- ▶ The correct opening and closing of the safety function relays is tested automatically in each on-off cycle.
- ▶ The unit has an electronic fuse.

Unit description

The safety relay meets the requirements of EN 60947-5-1, EN 60204-1 and VDE 0113-1 and may be used in applications with

- ▶ E-STOP pushbuttons
- ▶ Safety gates

Block diagram

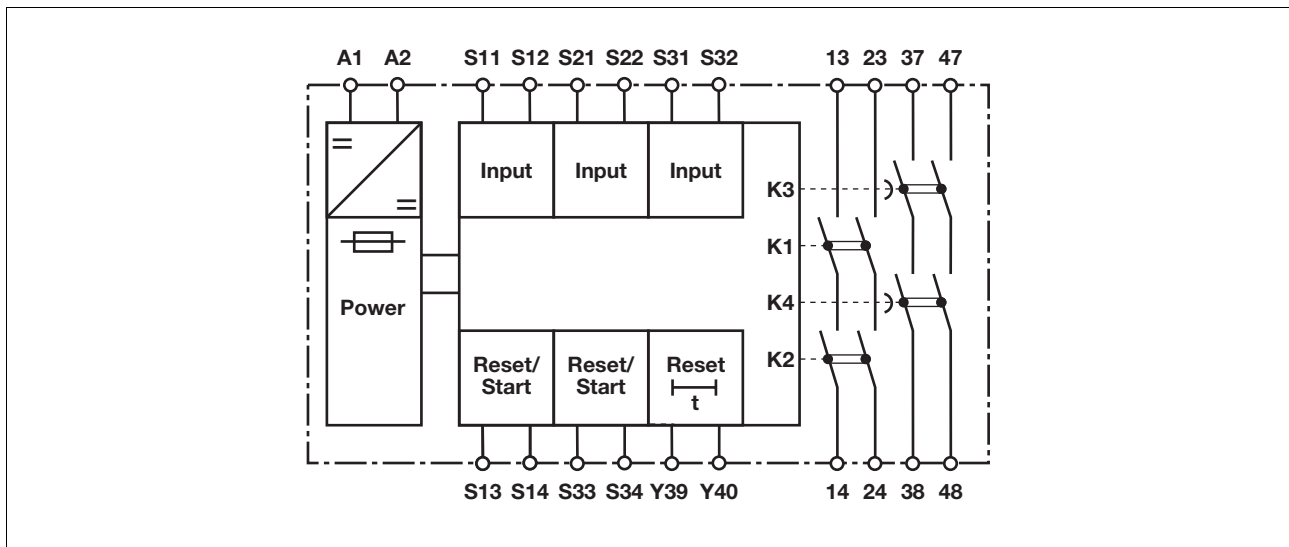

Up to Category 4, EN 954-1 PNOZ XV2

Function description

- ▶ Single-channel operation: no redundancy in the input circuit, earth faults in the reset circuit are detected.
- ▶ Dual-channel operation with detection of shorts across contacts: redundant input circuit, detects
 - earth faults in the reset and input circuit,
 - short circuits in the input circuit and, with a monitored reset, in the reset circuit too,
 - shorts between contacts in the input circuit.
- ▶ Automatic start: Unit is active once the input circuit has been closed.
- ▶ Monitored reset: Unit is active once the input circuit is closed and once the reset circuit is closed after the waiting period has elapsed (see technical details).
- ▶ Increase in the number of available contacts by connecting contact expander modules or external contactors/relays.

Timing diagram

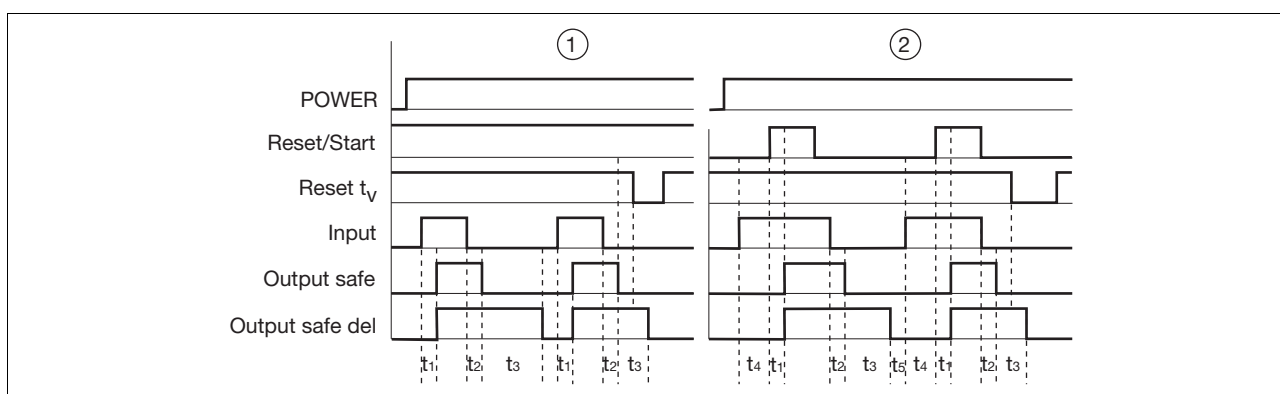

Key

- ▶ Power: Supply voltage
- ▶ Reset/start: Reset circuit S13-S14, S33-S34
- ▶ Reset t_v : Y39-Y40
- ▶ Input: Input circuits S11-S12, S21-S22, S31-S32
- ▶ Output safe: Safety contacts, instantaneous 13-14, 23-24
- ▶ Output safe del: Safety contacts, delayed 37-38, 47-48
- ▶ ①: Automatic reset
- ▶ ②: Monitored reset
- ▶ t_1 : Switch-on delay
- ▶ t_2 : Delay-on de-energisation
- ▶ t_3 : Delay time
- ▶ t_4 : Waiting period
- ▶ t_5 : Recovery time

Wiring

Please note:

- ▶ Information given in the “Technical details” must be followed.
- ▶ Outputs 13-14, 23-24 are instantaneous safety contacts, outputs 37-38, 47-48 are delay-on de-energisation safety contacts.
- ▶ To prevent contact welding, a fuse should be connected before the output contacts (see technical details).
- ▶ Calculation of the max. cable runs l_{max} in the input circuit:

$$l_{max} = \frac{R_{lmax}}{R_l / km}$$

R_{lmax} = max. overall cable resistance (see technical details)

R_l / km = cable resistance/km

- ▶ Use copper wire that can withstand 60/75 °C.

- ▶ Sufficient fuse protection must be provided on all output contacts with capacitive and inductive loads.

Up to Category 4, EN 954-1 PNOZ XV2

Preparing for operation

► Supply voltage

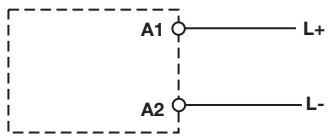
Supply voltage	AC	DC
		

► Input circuit

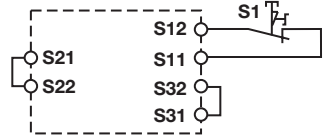
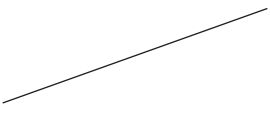
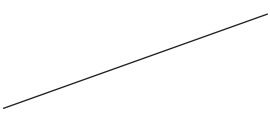
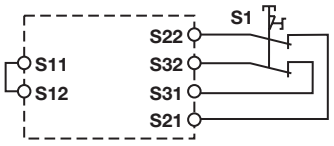
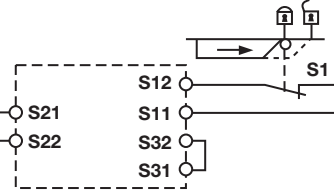
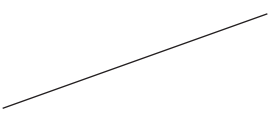
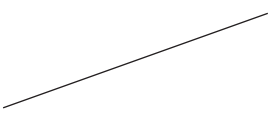
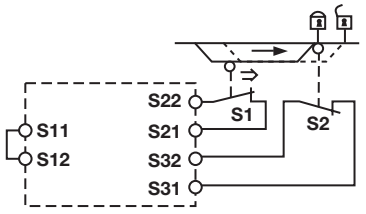
Input circuit	Single-channel	Dual-channel
E-STOP without detection of shorts across contacts		
E-STOP with detection of shorts across contacts		
Safety gate without detection of shorts across contacts		
Safety gate with detection of shorts across contacts		

Up to Category 4, EN 954-1 PNOZ XV2

▶ Reset circuit

Reset circuit	E-STOP wiring (single-channel) Safety gate (single-channel)	E-STOP wiring (dual-channel) Safety gate (dual-channel)
Automatic reset		
Monitored reset		



▶ Reset delay time

Reset	Without reset	With reset
Link or N/C contact		

▶ Feedback loop

Feedback loop	Automatic reset	Monitored reset
Contacts from external contactors		

▶ Key

S1/S2	E-STOP/safety gate switch
S3	Reset button
	Switch operated
	Gate open
	Gate closed

Up to Category 4, EN 954-1 PNOZ XV2

Terminal configuration

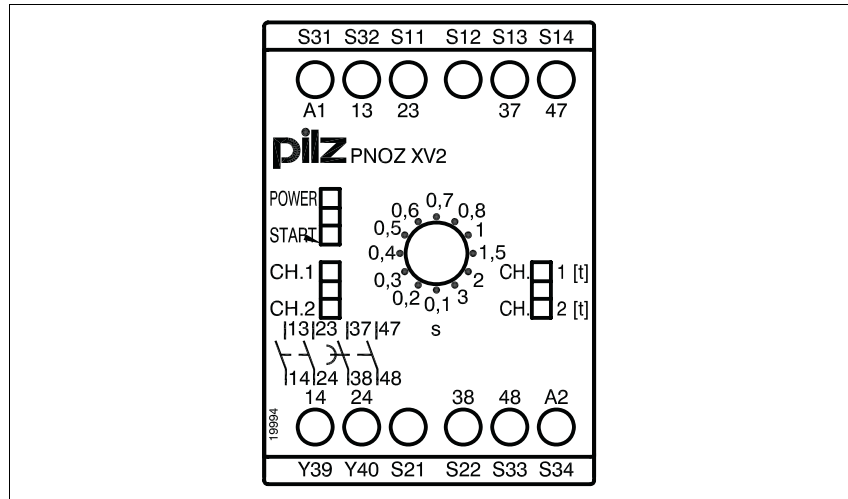

Installation

- ▶ The safety relay should be installed in a control cabinet with a protection type of at least IP54.
- ▶ Use the notch on the rear of the unit to attach it to a DIN rail.
- ▶ Ensure the unit is mounted securely on a vertical DIN rail (35 mm) by using a fixing element (e.g. retaining bracket or an end angle).

Dimensions

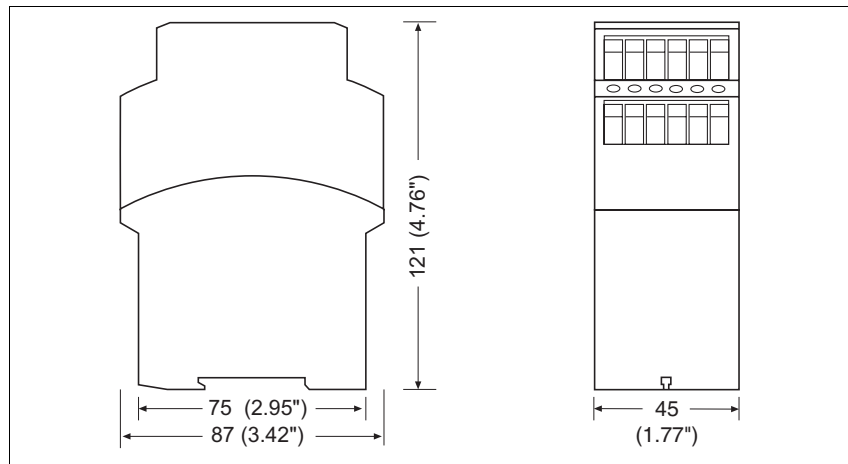

Up to Category 4, EN 954-1 PNOZ XV2

Notice

This data sheet is only intended for use during configuration. For installation and operation, please refer to the operating instructions supplied with the unit.

Service life graph

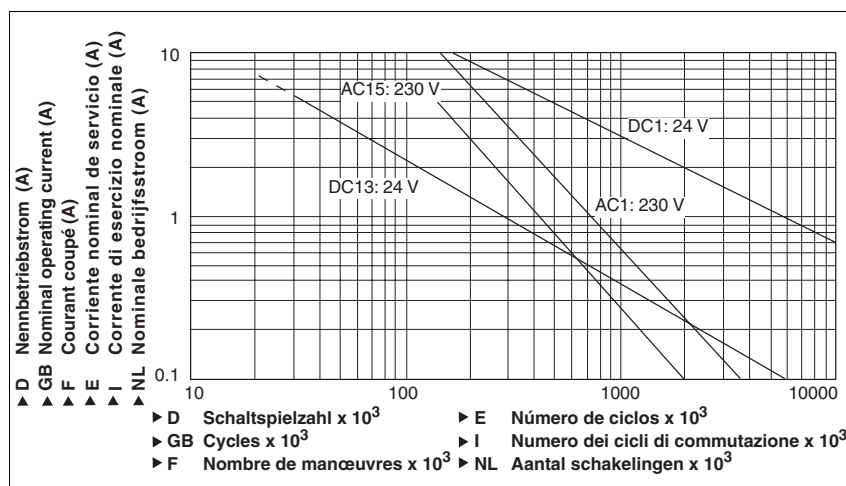

Technical details

Electrical data

Supply voltage	
Supply voltage U_B DC	24 V
Voltage tolerance	-15 %/+10 %
Power consumption at U_B DC	4.5 W
Residual ripple DC	160 %
Voltage and current at	
Input circuit DC: 24.0 V	35.0 mA
Reset circuit DC: 24.0 V	40.0 mA
Feedback loop DC: 24.0 V	3.5 mA
Number of output contacts	
Safety contacts (S) instantaneous:	2
Safety contacts (N/O), delayed:	2
Category of output contacts in accordance with EN 954-1	
Safety contacts (S) instantaneous:	4
Delay time <30 s	3
Delay time ≥30 s	1 Order no.: 774500, 774508
Utilisation category in accordance with EN 60947-4-1	
Safety contacts: AC1 at 240 V	$I_{min}: 0.01 A, I_{max}: 8.0 A$ $P_{max}: 2000 VA$
Safety contacts: DC1 at 24 V	$I_{min}: 0.01 A, I_{max}: 8.0 A$ $P_{max}: 200 W$
Safety contacts, delayed: AC1 at 240 V	$I_{min}: 0.01 A, I_{max}: 8.0 A$ $P_{max}: 2000 VA$
Safety contacts, delayed: DC1 at 24 V	$I_{min}: 0.01 A, I_{max}: 8.0 A$ $P_{max}: 200 W$
Utilisation category in accordance with EN 60947-5-1	
Safety contacts: AC15 at 230 V	$I_{max}: 5.0 A$
Safety contacts: DC13 at 24 V (6 cycles/min)	$I_{max}: 7.0 A$
Safety contacts, delayed: AC15 at 230 V	$I_{max}: 5.0 A$
Safety contacts, delayed: DC13 at 24 V (6 cycles/min)	$I_{max}: 7.0 A$
Contact material	AgSnO₂ + 0.2μ Au

Up to Category 4, EN 954-1 PNOZ XV2

Electrical data	
External contact fuse protection ($I_K = 1 \text{ kA}$) to EN 60947-5-1	
Blow-out fuse, quick	
Safety contacts:	10 A
Safety contacts, delayed:	10 A
Blow-out fuse, slow	
Safety contacts:	6 A
Safety contacts, delayed:	6 A
Circuit breaker 24 VAC/DC, characteristic B/C	
Safety contacts:	6 A
Safety contacts, delayed:	6 A
Max. overall cable resistance R_{lmax} input circuits, reset circuits	
single-channel at U_B DC	100 Ohm
dual-channel with detect. of shorts across contacts at U_B DC	10 Ohm
Times	
Switch-on delay	
with automatic reset typ.	350 ms
with automatic reset max.	650 ms
with automatic reset after power on typ.	385 ms
with automatic reset after power on max.	700 ms
on monitored reset with rising edge typ.	35 ms
on monitored reset with rising edge max.	70 ms
Delay-on de-energisation	
with E-STOP typ.	15 ms
with E-STOP max.	30 ms
with power failure typ.	85 ms
with power failure max.	200 ms
Recovery time at max. switching frequency 1/s after E-STOP	
after power failure	50 ms +tv
Delay time t_V : selectable	0,00 s; 0,50 s; 1,00 s; 2,00 s; 4,00 s; 6,00 s; 8,00 s; 10,00 s; 15,00 s; 20,00 s; 25,00 s; 30,00 s Order no.: 774500
	0,10 s; 0,20 s; 0,30 s; 0,40 s; 0,50 s; 0,60 s; 0,70 s; 0,80 s; 1,00 s; 1,50 s; 2,00 s; 3,00 s Order no.: 774502
	0,00 s; 5,00 s; 10,00 s; 20,00 s; 40,00 s; 60,00 s; 80,00 s; 100,00 s; 150,00 s; 200,00 s; 250,00 s; 300,00 s Order no.: 774508
Delay time t_V : fixed	0.50 s Order no.: 774504
	10.00 s Order no.: 774506
	3.00 s Order no.: 774505
Repetition accuracy	2 %
Time accuracy	-15% / +15% +50 ms
Waiting period with a monitored reset with rising edge	
	300 ms
Min. start pulse duration with a monitored reset with rising edge	
	30 ms
Simultaneity, channel 1 and 2	
	∞
Supply interruption before de-energisation	
	20 ms
Environmental data	
EMC	
	EN 60947-5-1, EN 61000-6-2
Vibration to EN 60068-2-6	
Frequency	10 - 55 Hz
Amplitude	0.35 mm
Climatic suitability	
	EN 60068-2-78
Airgap creepage in accordance with EN 60947-1	
Pollution degree	2
Rated insulation voltage	
	250 V
Rated impulse withstand voltage	
	4.0 kV
Ambient temperature	
	-10 - 55 °C

Up to Category 4, EN 954-1 PNOZ XV2

Environmental data	
Storage temperature	-40 - 85 °C
Protection type	
Mounting (e.g. cabinet)	IP54
Housing	IP40
Terminals	IP20
Mechanical data	
Housing material	
Housing	PPO UL 94 V0
Front	ABS UL 94 V0
Max. cross section of external conductors with screw terminals	
1 core flexible	0.20 - 4.00 mm ² , 24 - 10 AWG
2 core, same cross section, flexible:	
with crimp connectors, without insulating sleeve	0.20 - 2.50 mm ² , 24 - 14 AWG
without crimp connectors or with TWIN crimp connectors	0.20 - 2.50 mm ² , 24 - 14 AWG
Torque setting with screw terminals	0.60 Nm
Dimensions	
Height	87.0 mm
Width	45.0 mm
Depth	121.0 mm
Weight	340 g Order no.: 774504, 774505, 774506 350 g Order no.: 774500, 774502, 774508

The standards current on 11/03 apply.

Conventional thermal current	
I_{th} (A) at U_B DC	
1 contact	8.00 A
2 contacts	6.80 A
3 contacts	5.50 A
4 contacts	4.80 A

Order reference					
Type	Features			Terminals	Order no.
PNOZ XV2		24 VDC	0.5 s fixed	Screw terminals	774 504
PNOZ XV2		24 VDC	3.0 s fixed	Screw terminals	774 505
PNOZ XV2		24 VDC	10.0 s fixed	Screw terminals	774 506
PNOZ XV2		24 VDC	3 s selectable	Screw terminals	774 502
PNOZ XV2		24 VDC	30 s selectable	Screw terminals	774 500
PNOZ XV2		24 VDC	300 s selectable	Screw terminals	774 508