



**PNOZ safety relays;
PNOZmulti configurable control system**

pilz





Safety relays PNOZ X,
PNOZsigma, PNOZelog and PNOZpower;
PNOZmulti configurable control system

The optimum safety solution for every requirement.

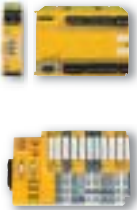

the spirit of safety

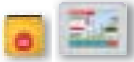
► Business activities

Excellent Components

Sensor technology	<ul style="list-style-type: none"> ▶ Safety switches ▶ Safety gate systems ▶ Safety light beams/curtains/grids ▶ Camera-based protection and measuring systems ▶ Safe camera systems 	
Control technology	<ul style="list-style-type: none"> ▶ Electronic monitoring relays ▶ Safety relays ▶ Configurable control systems ▶ Compact programmable control systems ▶ Modular programmable control systems ▶ Decentralised periphery 	
Networks	<ul style="list-style-type: none"> ▶ Network components ▶ Industrial communication 	
Drive technology	<ul style="list-style-type: none"> ▶ Motion control systems ▶ Servo amplifiers ▶ Motors 	
Operator and visualisation systems	<ul style="list-style-type: none"> ▶ Control and signal devices ▶ Operator terminals 	
Software	<ul style="list-style-type: none"> ▶ System software and tools ▶ Application software 	

Professional Services

Consulting and engineering	<ul style="list-style-type: none"> ▶ Risk Assessment ▶ Safety Concept ▶ Safety Design ▶ System Implementation ▶ Safety Validation ▶ CE Marking ▶ International Compliance Services ▶ Plant Assessment ▶ Inspection of ESPE 	
Training	<ul style="list-style-type: none"> ▶ Seminars ▶ Courses 	



Support

Technical help round the clock!

Technical support is available from Pilz round the clock. This service is provided free of charge beyond standard business hours.

Americas

- ▶ Brazil
+55 11 8245-8267
- ▶ Mexico
+52 55 5572 1300
- ▶ USA (toll-free)
+1 877-PILZUSA (745-9872)

Asia

- ▶ China
+86 21 62494658-216
- ▶ Japan
+81 45 471-2281
- ▶ Korea
+82 2 2263 9540

Australia

- ▶ Australia
+61 3 95446300

Europe

- ▶ Austria
+43 1 7986263-0
- ▶ Belgium, Luxembourg
+32 9 3217575
- ▶ England
+44 1536 462203
- ▶ France
+33 3 88104000
- ▶ Germany
+49 711 3409-444
- ▶ Ireland
+353 21 4804983
- ▶ Italy
+39 031 789511
- ▶ Scandinavia
+45 74436332
- ▶ Spain
+34 938497433
- ▶ Switzerland
+41 62 88979-30
- ▶ The Netherlands
+31 347 320477
- ▶ Turkey
+90 216 5775552

**You can reach our
international hotline on:**

+49 711 3409-444

Pilz GmbH & Co. KG
Felix-Wankel-Straße 2
73760 Ostfildern, Germany

Telephone: +49 711 3409-0
Telefax: +49 711 3409-133
E-Mail: pilz.gmbh@pilz.de
Internet: www.pilz.com



► Why does Pilz offer more?

Because the integrality of our business activities is what sets us apart.



Pilz is a solution supplier for all automation functions. Including standard control functions. Developments from Pilz protect man, machine and the environment. That's why all our experience and knowledge goes into individual products as well as consistently sophisticated system solutions.

- ▶ Sensor technology
- ▶ Control technology
- ▶ Networks
- ▶ Drive technology
- ▶ Operator and visualisation systems
- ▶ Software
- ▶ Consulting and engineering
- ▶ Training

Appropriate services relating to individual components and independent generic services guarantee that our customers obtain customised automation solutions, all from one source.

Pilz is a family business that's closer to its customers.

Pilz has a tradition as a family-run company stretching back 60 years.

Real proximity to customers is visible in all areas, instilling confidence through individual consultation, flexibility and reliable service.

We are your contact, guide and competency leader en route to an optimum automation solution.



PNOZ safety relays – The original

Applications worldwide

Every day PNOZ safety relays prove themselves in millions of applications worldwide. With its PNOZ safety relays Pilz is world market leader.

Synonym for safety

In 1987 Pilz developed the first emergency stop relay to protect man and machine. That was a milestone in safety technology. The name PNOZ is now synonymous with safety relays.

For each application

In consultation with our customers we are constantly developing the technology for numerous applications. Our current product portfolio includes the following product ranges:

- ▶ PNOZ X
- ▶ PNOZsigma
- ▶ PNOZelog
- ▶ PNOZpower
- ▶ PNOZmulti

That way you get the optimum safety solution for each requirement!

Contents

▶ Pilz product ranges	4
▶ Control technology product range	6
▶ PMD electronic monitoring relays product group	
- PMDsigma electronic monitoring relays.....	10
- PMDsrage electronic monitoring relays.....	12
▶ PNOZ safety relays product group	
- PNOZ X safety relays.....	14
- PNOZsigma safety relays	22
- PNOZelog safety relays	32
- PNOZpower safety relays.....	40
▶ PNOZmulti configurable control systems product group	
- PNOZmulti configurable control system.....	48



▶ Solution suppliers for safety and standard



Pilz offers a universal concept for solutions that can be applied right across industry. Whether you need safety or standard control functions, machine or plant, centralised or decentralised, a single product or a total solution: With Pilz you will definitely find a solution for your automation function.

Are you looking for a flexible solution for your automation functions?

- ▶ **PMD:** Electronic monitoring relays such as voltage or true power monitors, for example.
- ▶ **PNOZ:** Safety relays for simple plant and machinery with up to 4 safety functions. Safe monitoring of E-STOPS, safety gates and light curtains/light grids, for example.
- ▶ **PNOZmulti:** The safety circuit is created using a simple configuration tool. Applicable from 4 safety functions.
- ▶ **PSS:** Programmable control systems for use on complex machinery or distributed plants, to monitor safety-related functions and/or for complete machine control.
- ▶ **Industrial communication:** Transfer input/output signals and control data reliably and safely.



Your requirements:

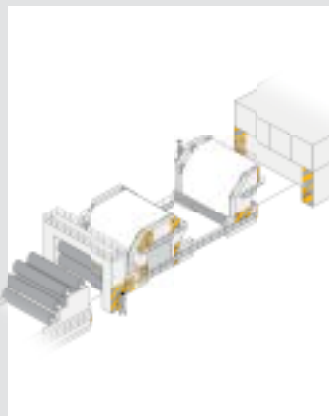

Our solution:



PMD electronic monitoring relays



PNOZ safety relays

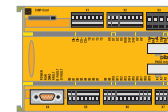

PNOZmulti configurable control system



PSS programmable control systems



Industrial communication networks

Supplementary product ranges:

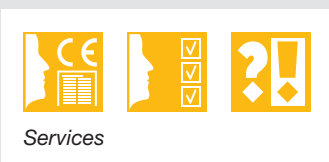
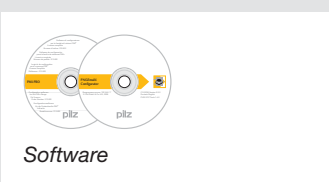
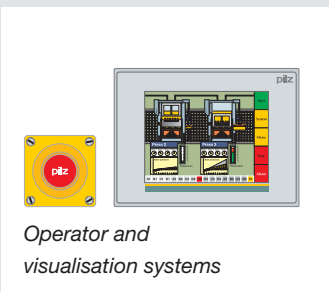
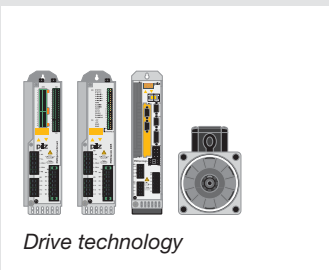
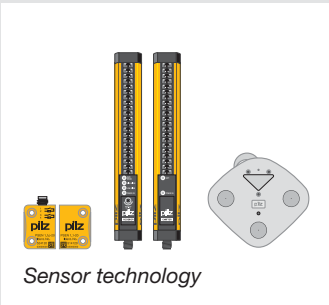

Products for safety and standard

Besides "Control technology" and "Networks", other product ranges also contain first-class components, which you can use individually or combine to form a system.

Sensor technology, used in conjunction with Pilz safe control technology, offers a co-ordinated, complete solution that's economical, approved and safe. The focus is always on the protection of man and machine, in compliance with the standards and regulations.

Drive technology provides overall solutions for automating your machinery. From controller operation through to movement of highly dynamic drives, including all safety aspects.

Operator and visualisation systems provide diagnostic and visualisation devices, plus control and signal devices as part of the Pilz solution. The focus is always on fast, simple configuration. Machine downtimes are clearly reduced thanks to the overall diagnostic concept PVIS.

Software includes system software, user software and software tools. Here you'll find the right tool for every task. From product-related software to diagnostic software, through to the PAScal Safety Calculator.

Services in the field of machinery safety are covered holistically by Pilz. From risk assessment through to ESPE inspection. Pilz also offers a comprehensive range of training courses and seminars, covering generic issues relating to machinery safety as well as Pilz products.



The whole range of business activities at a glance:

 Webcode 0326

Online information at www.pilz.com



▶ PNOZ[®] safety relays and PNOZmulti confi

The optimum safety solution for each application! For us, safety is more than just a product. Safe control technology is based on experience and innovation. We are continually expanding

our product range in consultation with our customers. Based on their different features and functionalities, our safety relays can be divided into the following product ranges:

▶ PNOZ X

▶ PNOZsigma

▶ PNOZpower

POWER 16 A

▶ PNOZelog

▶ PNOZmulti

PNOZ X

- ▶ Customised safety for each function
- ▶ Electromechanical, volt-free
- ▶ AC/DC versions

PNOZsigma

- ▶ Maximum functionality in minimum width
- ▶ Operating modes and times are selectable
- ▶ Diagnostics in seconds

PNOZelog

- ▶ Easy to link
- ▶ Non-wearing
- ▶ Extended diagnostics

PNOZpower

- ▶ High loads from 8 A to 16 A
- ▶ Switch motor loads directly
- ▶ Modular output contacts

PNOZmulti

- ▶ Freely configurable
- ▶ Multifunctional
- ▶ Configurable control system

programmable control system

Finding your PNOZ

This diagram will help you choose. You have specific requirements, we have the right solution!

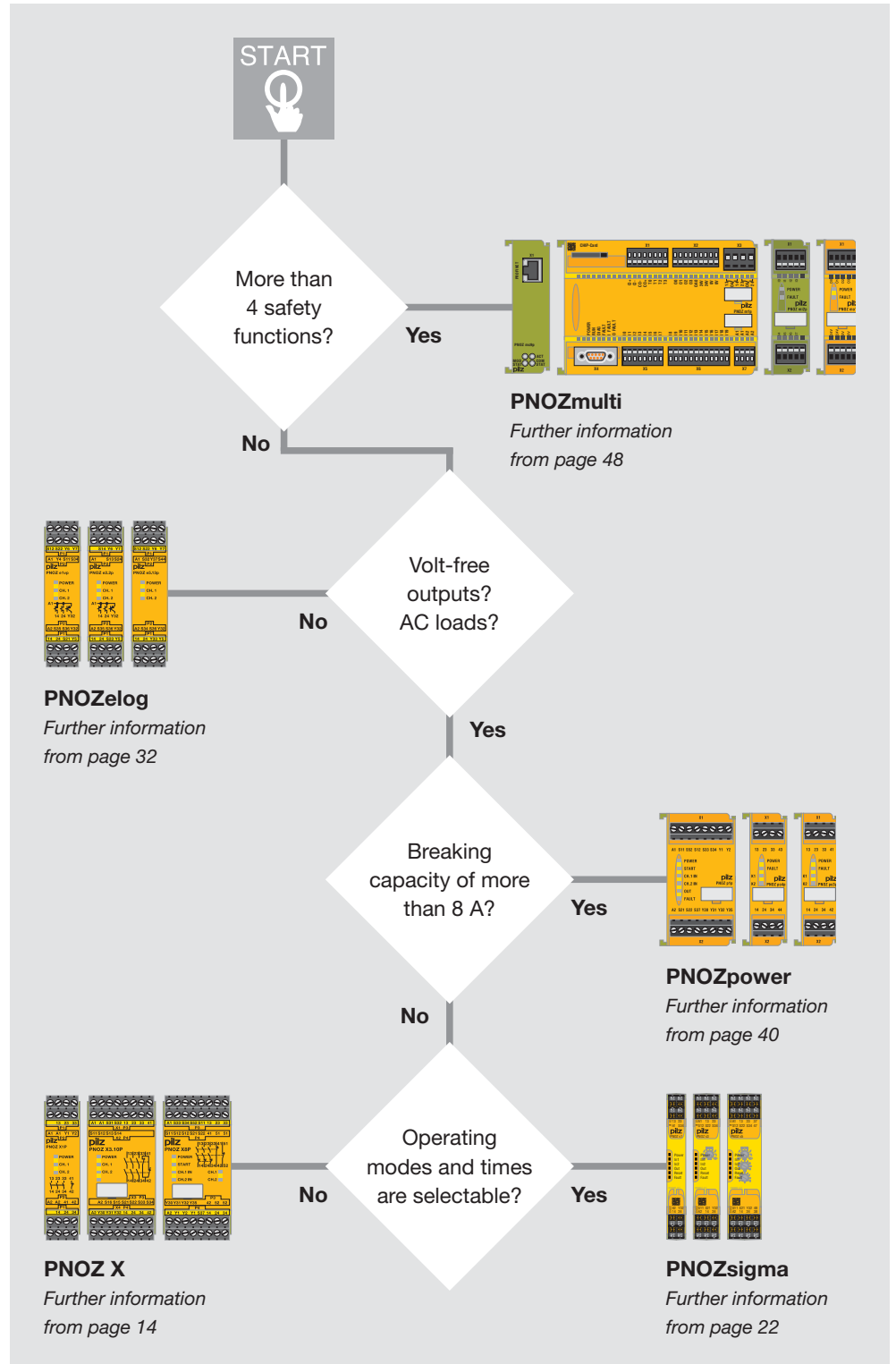



▶ The standard in safe control technology

It pays to use safety technology

The protection of man and machine through the targeted control of hazardous movements, cost savings thanks to fewer accidents, reduced downtimes and fewer production losses – these are real benefits that you can enjoy when you use safe control technology from Pilz.

PNOZ safety relays – Certified worldwide

When using PNOZ safety relays, the aim is to keep the risk to man and machine as low as possible. Internationally co-ordinated statutory instruments have been introduced to ensure that the same level of protection is guaranteed in all countries. Our safety relays comply with these international standards and regulations. The PNOZ safety relay has been approved by BG, TÜV and many other notified bodies and offers users considerable benefits. Long service life and high availability ensure it is cost-effective to use.

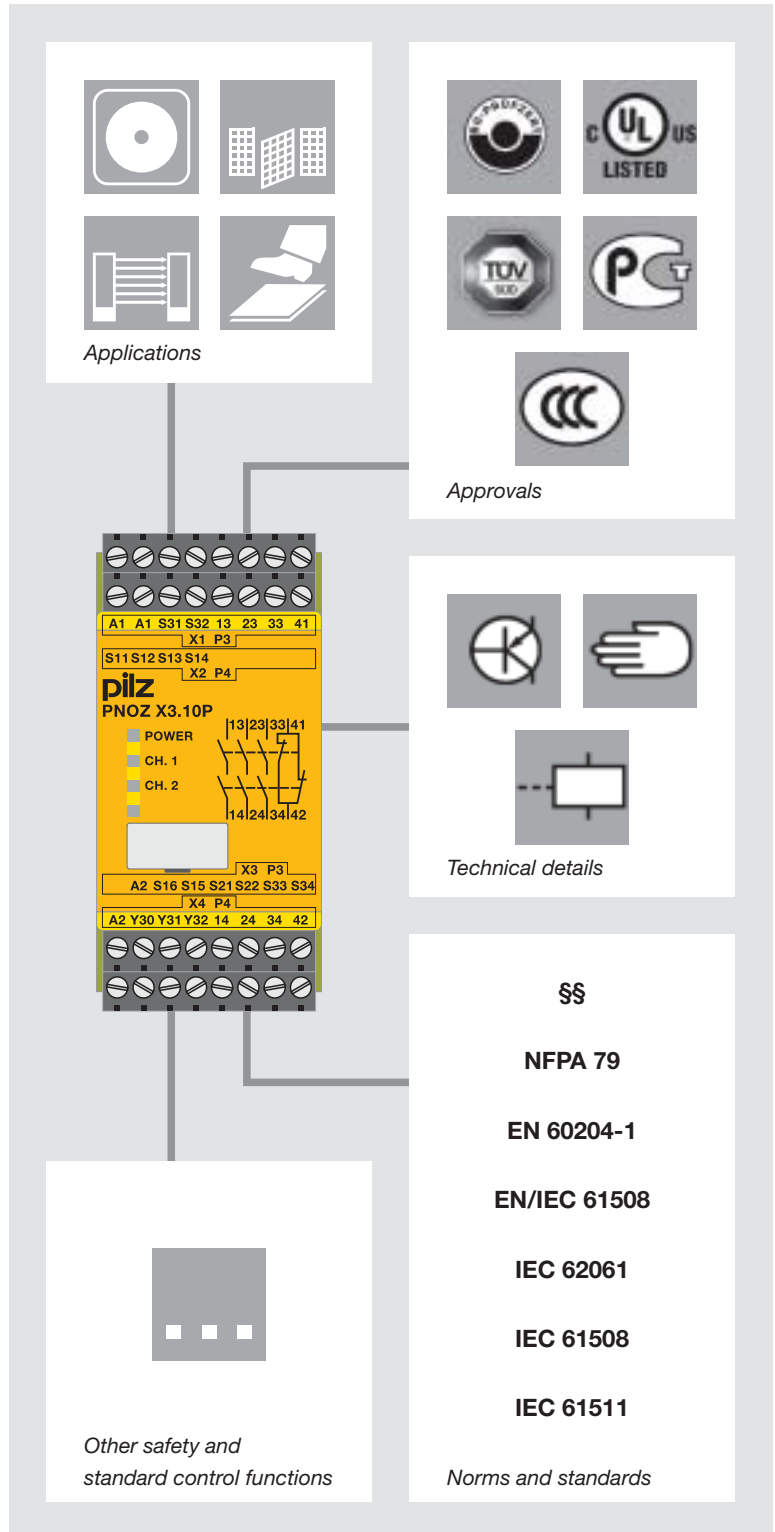

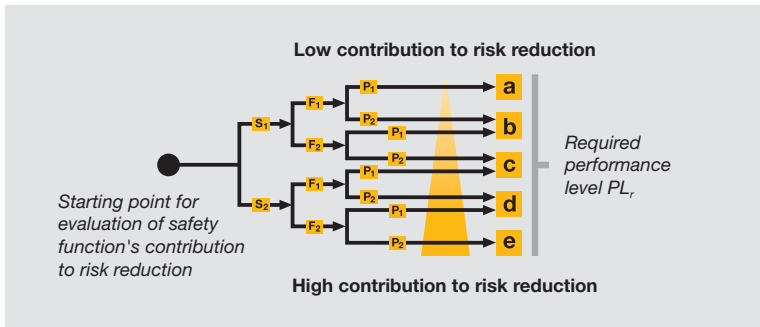

Risk assessment in accordance with EN 13849-1

EN ISO 13849-1

As the successor standard to EN 954-1, EN ISO 13849-1 is based on the familiar categories. Equally, it examines complete safety functions, including all the components involved in their

design. EN ISO 13849-1 goes beyond the qualitative approach of EN 954-1 to include a quantitative assessment of the safety functions. A performance level (PL) is used for this, building upon the categories.

Consequences and severity	Se	Class CL = Fr + Pr + Av				
		3-4	5-7	8-10	11-13	14-15
Death, loss of eye or arm	4	SIL 2	SIL 2	SIL 2	SIL 3	SIL 3
Permanent, loss of fingers	3		OM	SIL 1	SIL 2	SIL 3
Reversible, medical attention	2			OM	SIL 1	SIL 2
Reversible, first aid	1				OM	SIL 1

Risk assessment and definition of the required safety integrity level (SIL)

Safety assessment in accordance with EN/IEC 62061

According to the standard EN/IEC 62061, safety requirements in control technology can be divided into 3 categories. SIL 3 represents the highest risk reduction and protection level,

where the safety function must always be maintained. The risk is estimated through consideration of the severity of injury (Se), the frequency and duration of exposure to the hazard (Fr), probability of occurrence of a hazardous event (Pr) and the possibility of avoiding or limiting the harm (Av).

Your benefits at a glance

The use of PNOZ safety relays offers you:

- ▶ The security and innovative power of one of the leading brands in automation technology
- ▶ The appropriate solution for each application
- ▶ High plant availability thanks to user-friendly diagnostics
- ▶ Low downtimes for your plant or machinery
- ▶ Optimum cost/performance ratio
- ▶ Faster commissioning, for example, through units with plug-in terminals
- ▶ Maximum safety with minimum space requirement
- ▶ Simple wiring, fast commissioning
- ▶ A solid partner with expertise
- ▶ Certified safety, because our products comply with international standards and regulations and have been tested and approved worldwide
- ▶ Quality guarantee, we are certified to DIN ISO 9001
- ▶ Use of products that are geared towards the future, thanks to innovative developments
- ▶ Complete solution comprising evaluation devices, compatible sensor technology and control and signal devices

Find out more about the standards:



Webcode 0240

Online information at www.pilz.com



▶ Electrical safety with PMDsigma electronic



Simpler than it's ever been

PMDsigma is the new generation of electronic monitoring relays. You can reduce the number of hazardous situations for man and machine and increase the service life of plant and machinery. Save costs and guarantee an efficient production cycle.

On electronic monitoring relays, electrical safety is the focus. Voltage, current, temperature, phase sequence or similar variables are monitored, for example. The first unit in the PMDsigma product range monitors true power, more simply than ever before.

Applications

Using the measured true power, it is possible to derive variables such as fill level, volume, torque or air pressure, for example. The following applications provide some examples of the areas in which they might be used:

- ▶ Contamination on sieves or filters on ventilation systems
- ▶ To check for dry running or pump blockage
- ▶ Viscosity of fluids on mixers
- ▶ Wear and tear on tools
- ▶ To control the brush pressure on car washes
- ▶ To monitor conveyors for blockages or wear and tear

Your benefits at a glance

- ▶ For universal use: only one unit to stock
- ▶ Quick and easy settings, just turn and click, so set-up and commissioning times are short
- ▶ Error-proof: menu-driven configuration
- ▶ Ideal when exchanging units: configuration is stored on the chip card
- ▶ Simple diagnostics via the display mean minimum downtimes
- ▶ Approved for applications worldwide

Electronic monitoring relays – PMDsigma



PMD s10

Type	Features
<p>PMD s10 Monitors and converts true power for single/three-phase AC/DC supplies, relay and analogue outputs, monitors overload and underload</p> <p>Order number:</p> <ul style="list-style-type: none"> ▶ Spring-loaded terminals PMD s10C 761 100 ▶ Plug-in screw terminals PMD s10 760 100 	<ul style="list-style-type: none"> ▶ Measuring range set automatically ▶ Thresholds infinitely variable ▶ Function parameter settings are menu-driven (via display and encoder with key function) ▶ Analogue outputs for current and voltage. Voltage output 0 ... 10 V. Current output convertible from 0 ... 20 mA to 4 ... 20 mA. ▶ Relay outputs for monitoring underload and overload ▶ Suitable for use with frequency-controlled motors and current transformers <ul style="list-style-type: none"> ▶ Supply voltage: 24 ... 240 VAC/DC ▶ Output contacts: 2 auxiliary contacts (C/O) ▶ Measuring voltage 3 AC: 100 ... 550 V ▶ Measuring voltage 1 AC: 60 ... 320 V ▶ Measuring current: 1 ... 12 A ▶ Dimensions (H x W x D): 98 x 45 x 120 mm

monitoring relays

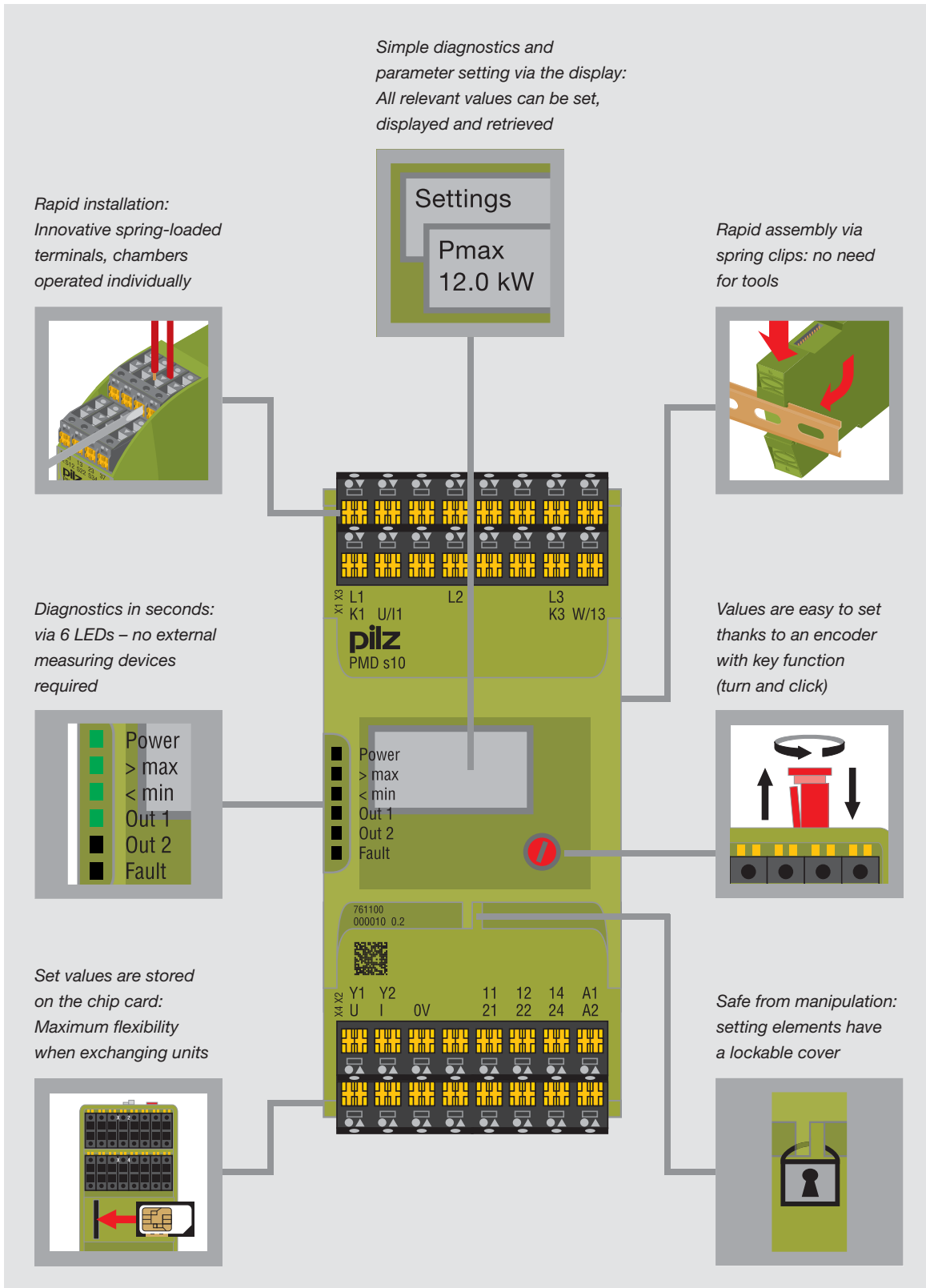

Keep up-to-date on PMDsigma:

Webcode 4089

Online information at www.pilz.com



► PMDsrage electronic monitoring relays

Taking control of every situation

Reliable electronic monitoring and control of plant and machinery is at the heart of our range of monitoring relays. PMDsrage units in 22.5 mm slimline housing cover up to 70 different functions.

In addition to current, voltage and insulation monitors, the range also includes relays for true power, phase sequence and thermistor monitoring. Quick and easy installation, practical terminals, a variety of operator elements as well as luminous displays all help to make commissioning easier and ensure the units are perfectly tailored to the specific application.

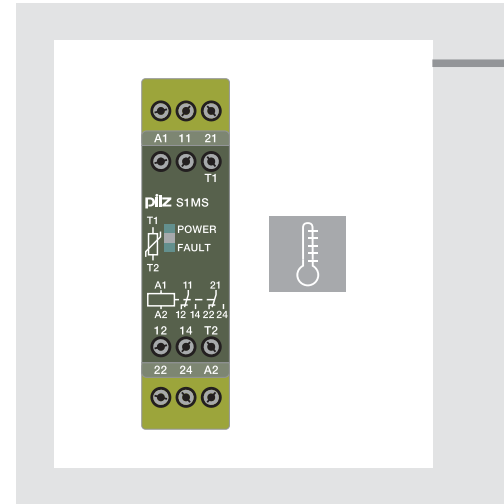

Electronic monitoring relays – PMDsrage

S3UM



Monitors AC voltages for overvoltage and undervoltage, phase sequence/failure and asymmetry, three-phase

- ▶ Monitors supplies with and without neutral conductors
- ▶ Trip device for undervoltage and overvoltage
- ▶ Evaluates phase sequence
- ▶ Detects asymmetry and phase failure
- ▶ Supply voltage (U_B): AC: 120, 230 V; DC: 24 V
- ▶ Output contacts: 1 auxiliary contact (C/O)
- ▶ Measuring voltage (U_M): AC: 42, 230, 100/110, 400/440, 415/460, 500/550 V, selectable
- ▶ Dimensions (H x W x D): 87 x 22.5 x 122 mm

Order number¹⁾:

- ▶ 24 VDC (U_B), 230 VAC (U_M) 837 260
- ▶ 24 VDC (U_B), 400/440 VAC (U_M) 837 270
- ▶ 24 VDC (U_B), 415/460 VAC (U_M) 837 280

S1PN

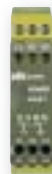

Monitors phase sequence and phase failure on three-phase supplies

- ▶ Measuring voltage up to 690 VAC
- ▶ Detects asymmetry
- ▶ Monitors phase sequence, phase failure, fuse
- ▶ Supply voltage (U_B): AC: 200 ... 240, 400 ... 500, 550 ... 690 V
- ▶ Output contacts: 2 auxiliary contacts (2 C/O)
- ▶ Dimensions (H x W x D): 87 x 22.5 x 122 mm
- Order number¹⁾:
 - ▶ 200 ... 240 V 890 200
 - ▶ 400 ... 500 V 890 210
 - ▶ 550 ... 690 V 890 220

S1IM



Monitors AC/DC currents for max. current values, single-phase

- ▶ 12 measuring ranges can be selected from 0.002 to 15 A
- ▶ Reaction time can be set to up to 10 seconds
- ▶ Either normally energised or normally de-energised mode
- ▶ Galvanic isolation between measuring and supply voltage
- ▶ Supply voltage: 24, 42 ... 48, 110 ... 127, 230 ... 240 V; DC: 24 V
- ▶ Output contacts: 1 auxiliary contact (C/O)
- ▶ Dimensions (H x W x D): 87 x 22.5 x 122 mm
- Order number¹⁾:
 - ▶ 110 ... 130 VAC (U_B), 15 A (I_M) 828 040
 - ▶ 230 ... 240 VAC (U_B), 15 A (I_M) 828 050
 - ▶ 24 VDC (U_B), 15 A (I_M) 828 035

¹⁾ Additional versions on request

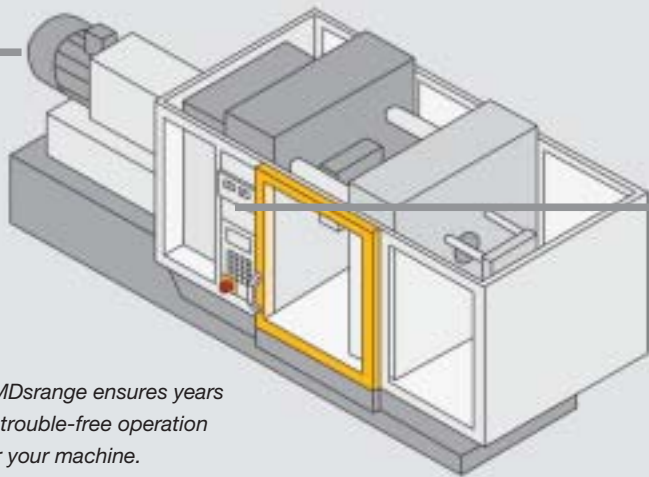

PMDsrange ensures years of trouble-free operation for your machine.

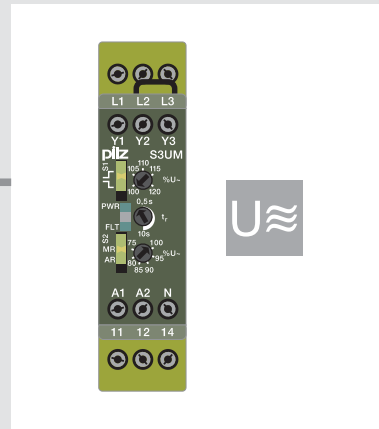

S1EN

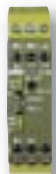

Monitors insulation and earth faults on AC/DC supplies, single and three-phase

- ▶ For DC and AC supplies
 - ▶ Normally energised mode
 - ▶ Fault latching or automatic reset
 - ▶ Normal/test mode

 - ▶ Supply voltage: 24 ... 240 VAC/DC
 - ▶ Output contacts: 1 auxiliary contact (C/O)
 - ▶ Rated mains voltage (monitored supply): 50 kΩ version: AC/DC: 0 ... 240 V
200 kΩ version: AC/DC: 0 ... 400 V
 - ▶ Dimensions (H x W x D): 87 x 22.5 x 122 mm
- Order number¹⁾:
- ▶ 24 ... 240 VAC/DC (U_B), 50 kΩ 884 100
 - ▶ 24 ... 240 VAC/DC (U_B), 200 kΩ 884 110

S1WP

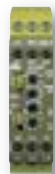

Monitors and converts true power, DC supplies and single/three-phase AC supplies, relay and analogue output, monitors overload and underload

- ▶ 9 different measuring ranges
 - ▶ Large voltage measuring range
 - ▶ Analogue output can be switched for current and voltage
 - ▶ Relay output for monitoring underload and overload
 - ▶ Suitable for use with frequency-controlled motors

 - ▶ Supply voltage: DC: 24 V, AC/DC: 230 V
 - ▶ Output contacts: 1 auxiliary contact (C/O)
 - ▶ Measuring voltage: 3 AC/1 AC/DC: 0 ... 120, 0 ... 240, 0 ... 415, 0 ... 550 V
 - ▶ Dimensions (H x W x D): 87 x 22.5 x 122 mm
- Order number¹⁾:
- ▶ 9 A (I_M), 24 VDC (U_B), 0 ... 240 VAC/DC 890 010
 - ▶ 9 A (I_M), 24 VDC (U_B), 0 ... 415 VAC/DC 890 020
 - ▶ 9 A (I_M), 24 VDC (U_B), 0 ... 550 VAC/DC 890 030

S1MS



Monitors the temperature of PTC temperature sensors to protect the motor from overheating

- ▶ For DC and AC supplies
 - ▶ Normally energised mode
 - ▶ Automatic reset

 - ▶ Supply voltage: AC: 48, 110, 120, 230, 400 V; AC/DC: 24 V
 - ▶ Output contacts: 2 auxiliary contacts (2 C/O)
 - ▶ Dimensions (H x W x D): 87 x 22.5 x 122 mm
- Order number¹⁾:
- ▶ 24 VAC/DC (U_B) 839 775
 - ▶ 230 VAC (U_B) 839 760
 - ▶ 400 VAC (U_B) 839 770



Order number features: U_B = Supply voltage; U_M = Measuring voltage; I_M = Measuring current



▶ PNOZ X safety relays

Customised safety for each application

Safety relays from the PNOZ X product range are proven through their reliability and robustness and have developed a wide application range in the most varied of safety applications. PNOZ is the most widely used safety relay in the world. One PNOZ is used per safety function. Its technical features are based on voltage-free, electromechanical contacts in 2 relay technology. Sizes vary from 22.5 to 90 mm, the number of contacts from two to eight. Whatever your safety requirement – PNOZ X has already proved itself a million times over in the rugged every-day industrial environment – and is certain to be the proven solution for you too.

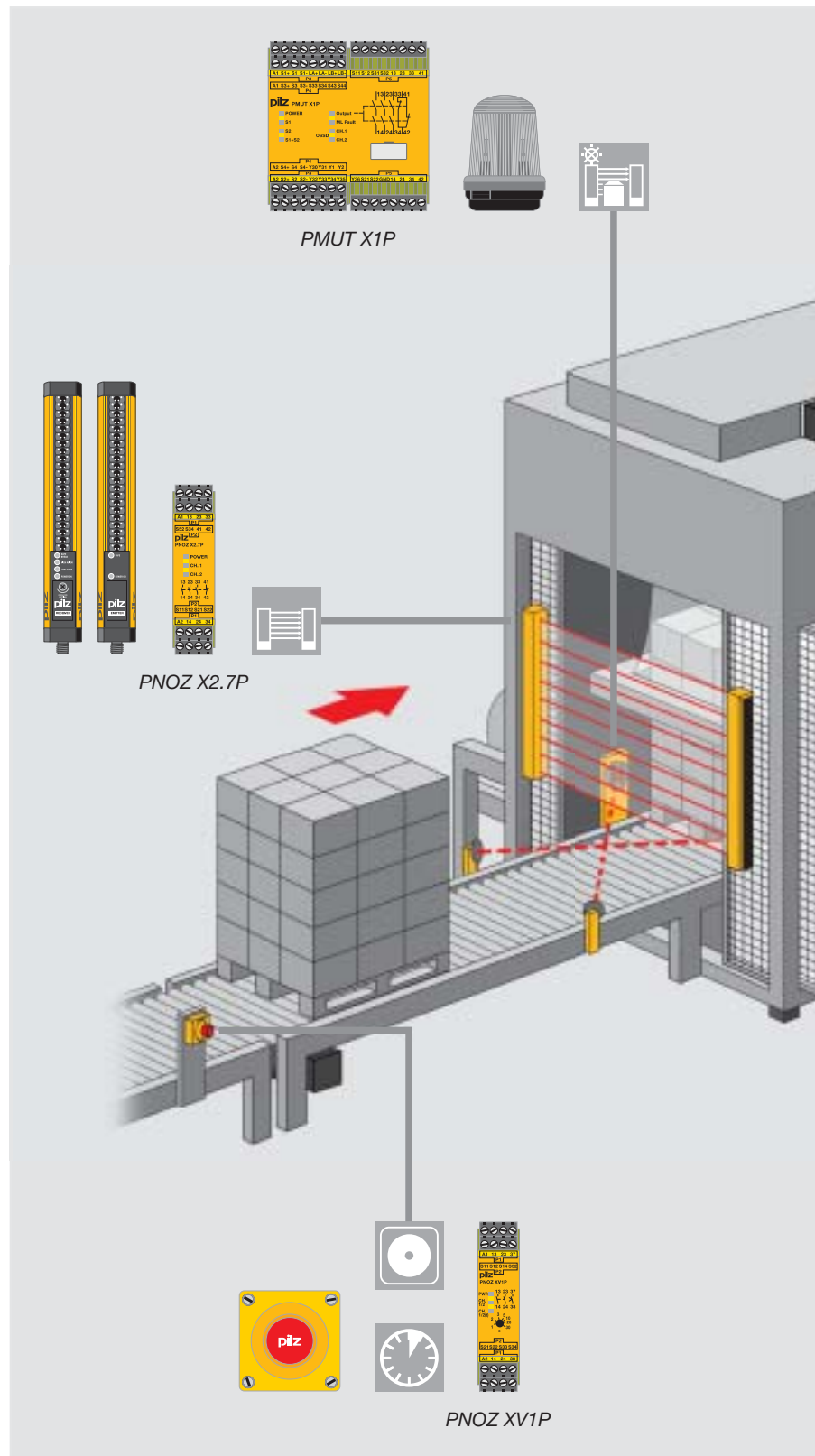

Example: using PNOZ X safety relays on a packaging machine.

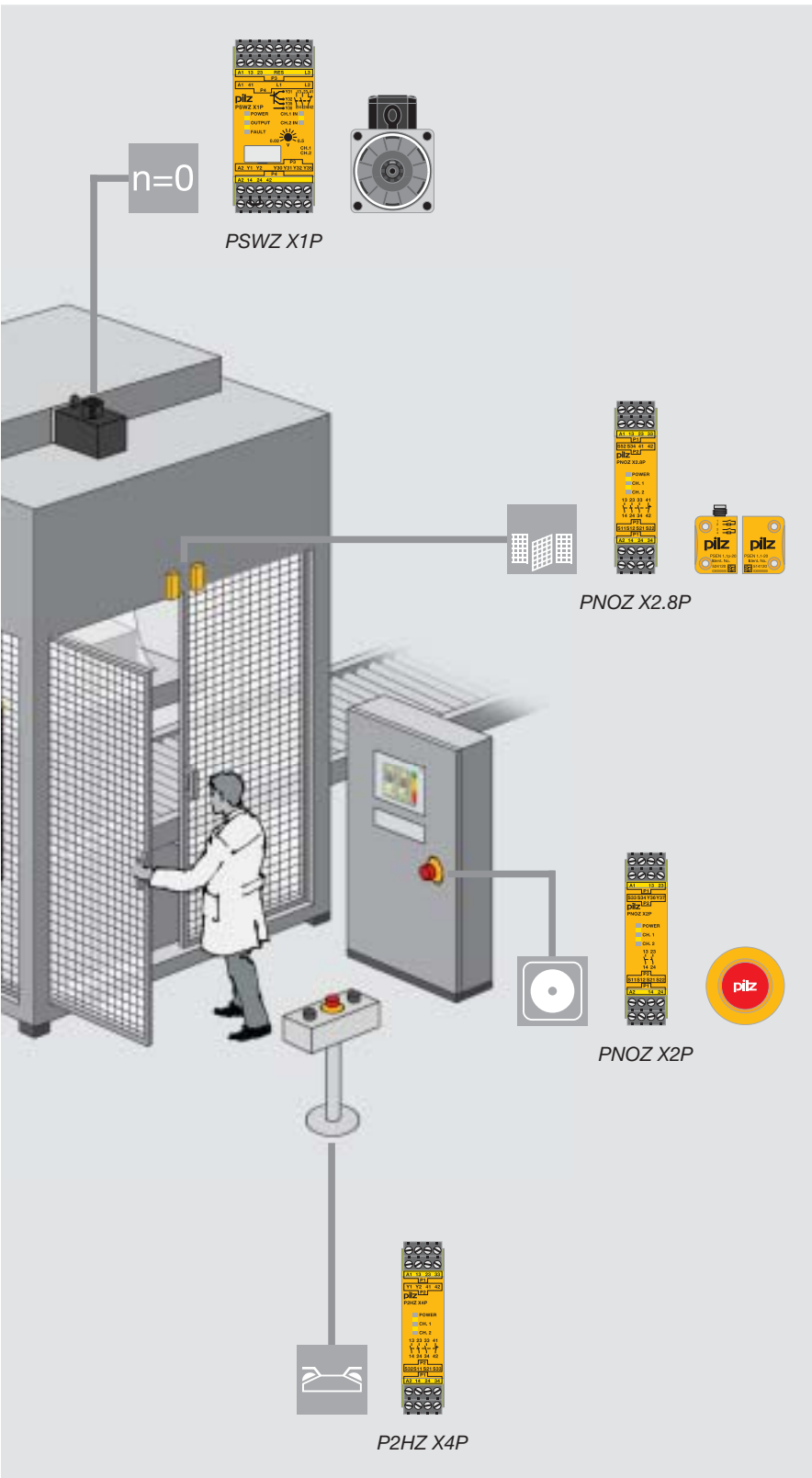

Your benefits at a glance

- ▶ Technology proven over many years of use
- ▶ Huge selection of products
- ▶ For all safety functions such as monitoring E-STOPS, safety gates, light beam devices-, muting, two-hand control and much more
- ▶ Delayed and instantaneous contact expansion modules, safe timers, safe monitoring relays for standstill, speed and other functions
- ▶ Excellent price/performance ratio
- ▶ Rapid commissioning thanks to plug-in terminals
- ▶ Maximum safety with minimum space requirement
- ▶ Complete solution comprising evaluation devices, compatible sensor technology and control and signal devices
- ▶ Low storage costs thanks to universal power supply and plug-in terminals

Keep up-to-date
on PNOZ X
safety relays:







Webcode 0210





Online information
at www.pitz.com



▶ Selection guide – PNOZ X

Safety relays – PNOZ X

Type	Application						Performance Level (PL) – EN ISO 13849-1	Safety Integrity Level (SIL) CL – claim limit in accordance with IEC 62061
								
PNOZ X1P	◆	◆					d	3
PNOZ X2P	◆	◆					e	3
PNOZ X2.7P	◆	◆	◆				e	3
PNOZ X2.8P	◆	◆	◆				e	3
PNOZ X3P	◆	◆	◆				e	3
PNOZ X7P	◆	◆					d	3
PNOZ X8P	◆	◆	◆				e	3
PNOZ X9P	◆	◆	◆				e	3
PNOZ X11P	◆	◆	◆				e	3
PNOZ XV1P	◆	◆	◆				e (d) ¹⁾	3
PNOZ XV3P	◆	◆	◆				e (d) ¹⁾	3
PNOZ XV3.1P	◆	◆	◆				e (d) ¹⁾	3
PMUT X1P	◆		◆	◆			e	3
P2HZ X1P					◆		e	3
P2HZ X4P					◆		e	3
PSWZ X1P						◆	e	3
PZE X4P	Contact expansion						e	3

Category (in accordance with EN 954-1)			Output contacts				Housing width in mm
			Safe		Non-safe		
2	3	4					
◆			3	-	1	-	22.5
◆		◆	2	-	-	-	22.5
◆	◆	◆	3	-	1	-	22.5
◆	◆	◆	3	-	1	-	22.5
◆	◆	◆	3	-	1	1	45.0
◆			2	-	-	-	22.5
◆	◆	◆	3	-	2	2	45.0
◆	◆	◆	7	-	2	2	90.0
◆	◆	◆	7	-	1	2	90.0
◆	◆	◆	2	1	-	-	22.5
◆	◆	◆	3	2	-	-	45.0
◆	◆	◆	3	2	1	-	90.0
◆	◆	◆	3	-	1	5	90.0
EN 574, Type IIIC	EN 574, Type IIIC	EN 574, Type IIIC	3	-	1	2	45.0
EN 574, Type IIIC	EN 574, Type IIIC	EN 574, Type IIIC	3	-	1	-	22.5
◆	◆		2	-	1	1	45.0
Depends on base unit			4	-	-	-	22.5

¹⁾ Value applies for instantaneous (delayed) safety contacts

Technical
documentation
on PNOZ X
safety relays:

 Webcode 0685

Online information
at www.pilz.com



► Technical details – PNOZ X

Safety relays – PNOZ X



PNOZ X1P



PNOZ X2.7P



PNOZ X3P



PNOZ X9P

Type	Supply voltage	Outputs: Voltage/current/rating	Dimensions in mm (H x W x D)
PNOZ X1P	24 VDC	DC1: 24 V/6 A/150 W	101/94 ¹⁾ x 22.5 x 121
PNOZ X2P	<ul style="list-style-type: none"> ▶ 24 VAC/DC ▶ 48 ... 240 VAC/DC 	DC1: 24 V/6 A/150 W	101/94 ¹⁾ x 22.5 x 121
PNOZ X2.7P PNOZ X2.8P	<ul style="list-style-type: none"> ▶ 24 VAC/DC ▶ 24 ... 240 VAC/DC 	DC1: 24 V/6 A/150 W	101/94 ¹⁾ x 22.5 x 121
PNOZ X3P	<ul style="list-style-type: none"> ▶ 24 VAC/DC ▶ 24 ... 240 VAC/DC 	DC1: 24 V/8 A/200 W	101/94 ¹⁾ x 45 x 121
PNOZ X7P	<ul style="list-style-type: none"> ▶ 24 VAC/DC ▶ 110 ... 120, 230 ... 240 VAC 	DC1: 24 V/6 A/150 W	101/94 ¹⁾ x 22.5 x 121
PNOZ X8P	<ul style="list-style-type: none"> ▶ 24 VDC ▶ 24, 110, 115, 120, 230 VAC 	DC1: 24 V/8 A/200 W	101/94 ¹⁾ x 45 x 121
PNOZ X9P	<ul style="list-style-type: none"> ▶ 24 VDC ▶ 24 VDC, 100 ... 240 VAC 	DC1: 24 V/8 A/200 W	101/94 ¹⁾ x 90 x 121
PNOZ X11P	<ul style="list-style-type: none"> ▶ 24 VDC, 24 VAC ▶ 110 ... 120, 230 ... 240 VAC 	DC1: 24 V/8 A/200 W	101/94 ¹⁾ x 90 x 121

Features	Order number	
	Spring-loaded terminals	Plug-in screw terminals
▶ 1-channel operation	787 100	777 100
▶ 2-channel operation with detection of shorts across contacts ▶ Automatic or monitored reset can be selected	▶ 24 VAC/DC 787 303 ▶ 48 ... 240 VAC/DC 787 307	▶ 24 VAC/DC 777 303 ▶ 48 ... 240 VAC/DC 777 307
▶ 2-channel operation with or without detection of shorts across contacts ▶ PNOZ X2.7P: Monitored reset ▶ PNOZ X2.8P: Automatic reset	▶ PNOZ X2.7P C - 24 VAC/DC 787 305 - 24 ... 240 VAC/DC 787 306 ▶ PNOZ X2.8P C - 24 VAC/DC 787 301 - 24 ... 240 VAC/DC 787 302	▶ PNOZ X2.7P - 24 VAC/DC 777 305 - 24 ... 240 VAC/DC 777 306 ▶ PNOZ X2.8P - 24 VAC/DC 777 301 - 24 ... 240 VAC/DC 777 302
▶ 2-channel operation with or without detection of shorts across contacts ▶ Monitored or automatic reset can be selected ▶ 1 semiconductor output ▶ Safety gate function with N/C / N/O combination	▶ 24 VAC/DC 787 310 ▶ 24 ... 240 VAC/DC 787 313	▶ 24 VAC/DC 777 310 ▶ 24 ... 240 VAC/DC 777 313
▶ 1-channel operation	▶ 24 VAC/DC 787 059 ▶ More available on request	▶ 24 VAC/DC 777 059 ▶ More available on request
▶ 2-channel operation with or without detection of shorts across contacts ▶ Monitored or automatic reset can be selected ▶ 2 semiconductor outputs	▶ 24 VAC 787 770 ▶ 24 VDC 787 760 ▶ More available on request	▶ 24 VAC 777 770 ▶ 24 VDC 777 760 ▶ More available on request
▶ 2-channel operation with or without detection of shorts across contacts ▶ Monitored or automatic reset can be selected ▶ 2 semiconductor outputs	▶ 24 VDC 787 609 ▶ 24 VDC, 100 ... 240 VAC 787 606	▶ 24 VDC 777 609 ▶ 24 VDC, 100 ... 240 VAC 777 606
▶ 2-channel operation with or without detection of shorts across contacts ▶ Monitored or automatic reset can be selected ▶ 2 semiconductor outputs	▶ 24 VDC, 24 VAC 787 080 ▶ 110 ... 120 VAC 787 083 ▶ 230 ... 240 VAC 787 086	▶ 24 VDC, 24 VAC 777 080 ▶ 110 ... 120 VAC, 24 VDC 777 083 ▶ 230 ... 240 VAC, 24 VDC 777 086



Technical documentation on PNOZ X safety relays:

Webcode 0685

Online information at www.pilz.com

¹⁾ Height with spring-loaded terminals/plug-in screw terminals



► Technical details – PNOZ X

Safety relays – PNOZ X



PNOZ XV1P



PNOZ XV3P



PMUT X1P



PZE X4P

Type	Supply voltage	Outputs: Voltage/current/rating	Dimensions in mm (H x W x D)
PNOZ XV1P	24 VDC	DC1: 24 V/5 A/125 W	101/94 ¹⁾ x 22.5 x 121
PNOZ XV3P	24 VDC	DC1: 24 V/8 A/200 W	101/94 ¹⁾ x 45 x 121
PNOZ XV3.1P	<ul style="list-style-type: none"> ▶ 24 VDC ▶ 24 ... 240 VAC/DC 	DC1: 24 V/8 A/200 W	101/94 ¹⁾ x 90 x 121
PMUT X1P	24 VDC	DC1: 24 V/8 A/200 W	101/94 ¹⁾ x 90 x 121
P2HZ X1P	<ul style="list-style-type: none"> ▶ 24 VDC ▶ 24, 42, 48, 110, 115, 120, 230, 240 VAC 	DC1: 24 V/2 A/50 W	101/94 ¹⁾ x 45 x 121
P2HZ X4P	24 VAC/DC	DC1: 24 V/5 A/125 W	101/94 ¹⁾ x 22.5 x 121
PSWZ X1P	24 ... 240 VAC/DC	DC1: 24 V/6 A/150 W	101/94 ¹⁾ x 45 x 121
PZE X4P	24 VDC	DC1: 24 V/5 A/120 W	101/94 ¹⁾ x 22.5 x 121

Features	Order number	
	Spring-loaded terminals	Plug-in screw terminals
<ul style="list-style-type: none"> ▶ 2-channel operation with or without detection of shorts across contacts ▶ Monitored or automatic reset can be selected 	<ul style="list-style-type: none"> ▶ 0.1 ... 3 s 787 601 ▶ 1 ... 30 s 787 602 	<ul style="list-style-type: none"> ▶ 0.1 ... 3 s 777 601 ▶ 1 ... 30 s 777 602
<ul style="list-style-type: none"> ▶ 2-channel operation with or without detection of shorts across contacts ▶ Monitored or automatic reset can be selected 	<ul style="list-style-type: none"> ▶ 3 s 787 512 ▶ 30 s 787 510 ▶ More available on request 	<ul style="list-style-type: none"> ▶ 3 s 777 512 ▶ 30 s 777 510 ▶ More available on request
<ul style="list-style-type: none"> ▶ 2-channel operation with or without detection of shorts across contacts ▶ Monitored or automatic reset can be selected ▶ Universal power supply 24 ... 240 VAC/DC 	<ul style="list-style-type: none"> ▶ 3 s selectable, 24 ... 240 VAC/DC..... 787 532 ▶ 30 s selectable, 24 ... 240 VAC/DC..... 787 530 ▶ More available on request 	<ul style="list-style-type: none"> ▶ 3 s selectable, 24 ... 240 VAC/DC..... 777 532 ▶ 30 s selectable, 24 ... 240 VAC/DC..... 777 530 ▶ More available on request
<ul style="list-style-type: none"> ▶ Up to 4 muting sensors ▶ Monitoring and switching muting lamps ▶ Parallel and serial muting ▶ Simultaneity monitoring ▶ 5 semiconductor outputs ▶ Reset input ▶ Override function via key switch in the case of a fault ▶ LED status indicators 	788 010	778 010
<ul style="list-style-type: none"> ▶ 2 semiconductor outputs 	<ul style="list-style-type: none"> ▶ 24 VDC 787 340 ▶ More available on request 	<ul style="list-style-type: none"> ▶ 24 VDC 777 340 ▶ More available on request
<ul style="list-style-type: none"> ▶ 22.5 mm width 	<ul style="list-style-type: none"> ▶ 24 VAC..... 787 354 ▶ 24 VDC 787 355 	<ul style="list-style-type: none"> ▶ 24 VAC..... 777 354 ▶ 24 VDC 777 355
<ul style="list-style-type: none"> ▶ Safe standstill monitoring ▶ 1 or 2-channel operation ▶ No external components required ▶ Fault signal if simultaneity time is exceeded ▶ Reset input ▶ Detects open circuits 	<ul style="list-style-type: none"> ▶ U_M: 0.5 V 787 949 ▶ U_M: 3 V 787 950 	<ul style="list-style-type: none"> ▶ U_M: 0.5 V 777 949 ▶ U_M: 3 V 777 950
<ul style="list-style-type: none"> ▶ 1-channel operation 	787 585	777 585



Technical documentation on PNOZ X safety relays:

Webcode 0685

Online information at www.pilz.com

¹⁾ Height with spring-loaded terminals/plug-in screw terminals



▶ PNOZsigma safety relays

Maximum functionality in minimum width

The new compact safety relays PNOZsigma combine many years of experience with today's very latest safety technology: you can achieve maximum safety and cost-effectiveness with minimum effort.

All-round efficiency – From planning to service

With particularly narrow housing widths and multifunctionality compressed into each unit, PNOZsigma provides maximum functionality in minimum width. Use safety technology that

- ▶ saves more space,
- ▶ is more flexible,
- ▶ quicker
- ▶ and therefore more efficient.

*PNOZsigma
brings maximum
efficiency – from
planning to service.*

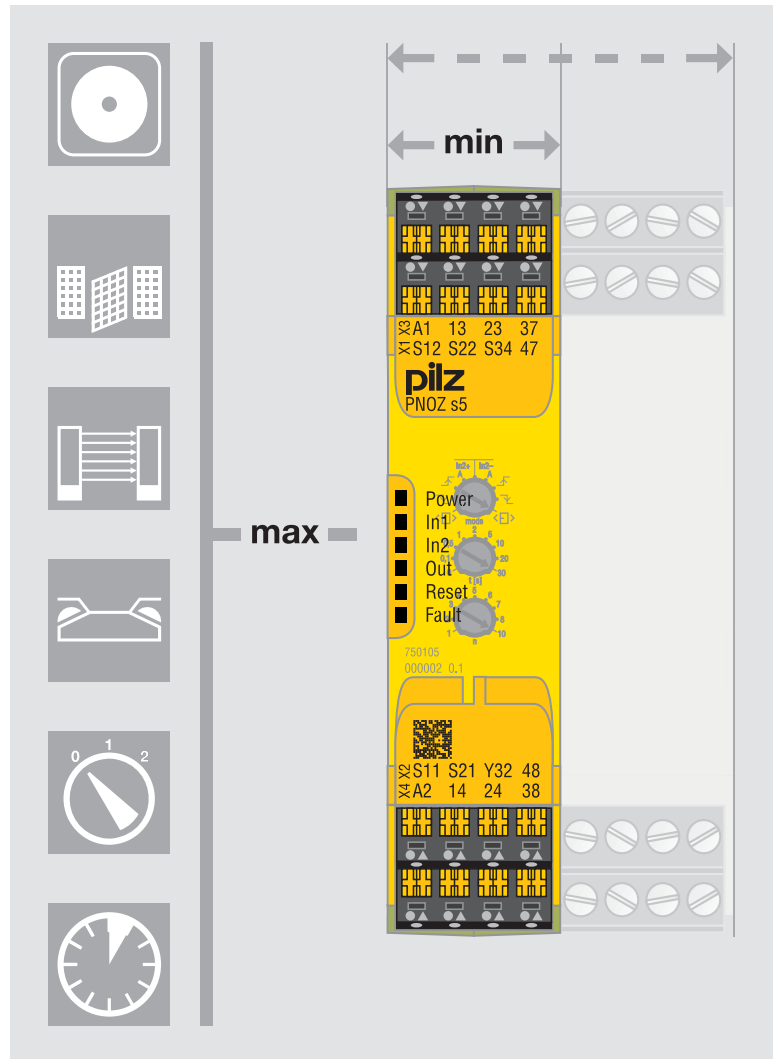

Up to 50 % space saving

- ▶ Widths from 12.5 mm
- ▶ Housings up to 50 % narrower with the same functionality¹⁾
- ▶ Reduced space requirement in the control cabinet saves costs

¹⁾ Compared with standard electromechanical safety relays on the market

Rapid commissioning and expansion thanks to innovative connection technology

- ▶ Just "click" to expand the contacts via a plug-in connection
- ▶ Plug-in connection terminals
- ▶ Innovative spring-loaded technology
- ▶ Reduces wiring by up to 20%

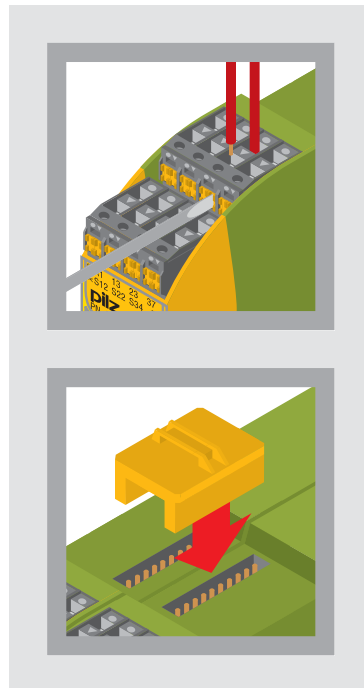

Your benefits at a glance

- ▶ Up to 50 % space saving in the control cabinet
- ▶ Rapid commissioning and expansion
- ▶ High availability and diagnostics in seconds
- ▶ Few unit types covering many safety functions

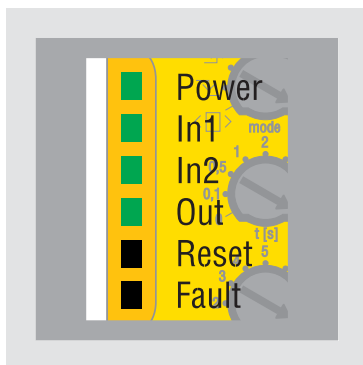

High plant availability and long service life

- ▶ Rapid diagnostics at a glance
- ▶ 6 descriptive LEDs
- ▶ High switching capabilities up to 12 A
- ▶ Safe switching even of the smallest loads from 10 mA



Fewer types – Suitable for a variety of uses

- ▶ Selectable operating modes and timers enable each unit to be flexible in its application
- ▶ A single unit type monitors various safety functions
- ▶ Your stockholding can be reduced to a few unit types

Keep up-to-date on PNOZsigma safety relays:



Online information at www.pilz.com



► The sum of our experience – PNOZsigma

*20% reduction in wiring:
Contact expansion via
connectors*

*Rapid installation: new –
innovative spring-loaded
terminals, chambers
operated individually*

*Simple configuration:
designation and position
of the terminals is the
same on all unit types*

*Maximum flexibility:
Operating modes and timer
functions are selectable*

*Rapid assembly
via spring clips:
no need for tools*

*Diagnostics in seconds:
via 6 LEDs – no external
measuring devices
required*

*Safe from manipulation:
setting elements have
a lockable cover*

⚡ A1 13 23 37
 ⚡ S12 S22 S34 47
pilz
 PNOZ s5

⚡ 13 23 33
 ⚡ A1 51 43
pilz
 PNOZ s7

Power
 In1
 In2
 Out
 Reset
 Fault

In1
 In2
 Out
 Fault

750105
 000002 0.5
 ⚡ S11 S21 Y32 48
 ⚡ A2 14 24 38

750107
 000002 0.7
 ⚡ A2 52 44
 ⚡ 14 24 34

0.1
 S21 Y3

Multiple expansion with PNOZ s7.1 and PNOZ s7.2

The latest highlight: the cascadable contact expansion modules PNOZ s7.1 and PNOZ s7.2.

With a base unit and a PNOZ s7.1, the number of safety contacts can be expanded almost without limit. Up to ten PNOZ s7.2 can be connected to a PNOZ s7.1. If you need more contacts, an additional PNOZ s7.1 can be added to the series. No wiring is involved, simply "click" in via a plug connection.

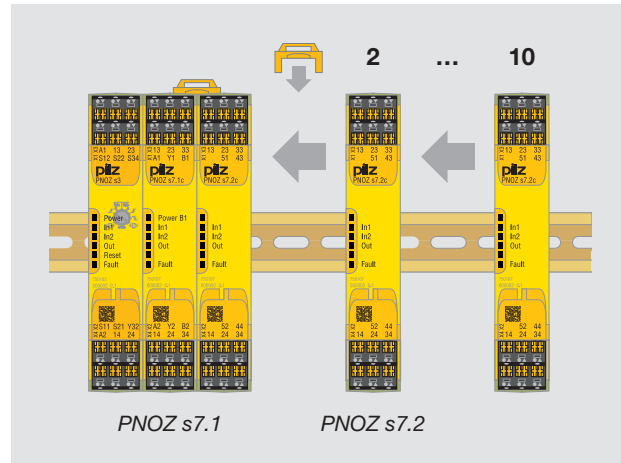

Linking contacts – it's easy with PNOZsigma!

At just 17.5 mm wide, the PNOZ s7.1 has three safety contacts, while the PNOZ s7.2 has four safety contacts plus one auxiliary contact. They can be combined with other expansion units at any time. Benefits of using PNOZsigma:

- ▶ Rapid commissioning
- ▶ Fewer unit types to keep in stock
- ▶ No additional accessories, everything is supplied with the unit
- ▶ Easier to maintain because units can be installed or removed individually

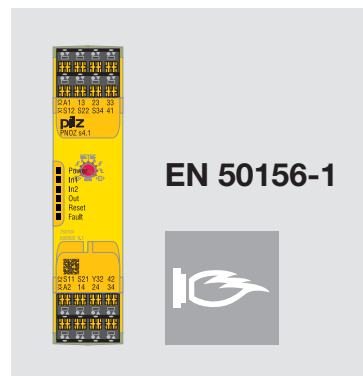

Safe firing with PNOZ s4.1





Thanks to three safe, diverse safety contacts, the PNOZ s4.1 is approved for use in burner controls. It is approved in accordance with the standard EN 50156-1 for electrical equipment on furnaces, in particular with regard to the requirements for application design and installation.









▶ Selection guide – PNOZsigma

Safety relays – PNOZsigma

Type	Application					Performance Level (PL) – EN ISO 13849-1	Safety Integrity Level (SIL) CL – claim limit in accordance with IEC 62061
							
PNOZ s1	◆	◆				c	2
PNOZ s2	◆	◆				d	3
PNOZ s3	◆	◆	◆			e	3
PNOZ s4	◆	◆	◆			e	3
PNOZ s4.1	◆	◆	◆			e	3
PNOZ s5	◆	◆	◆		◆	e	3
PNOZ s6				◆		e	3
PNOZ s6.1				◆		e	3
PNOZ s7	Contact expansion					e	3
PNOZ s7.1	Contact expansion					e	3
PNOZ s7.2	Contact expansion					e	3
PNOZ s8	Contact expansion					c	2
PNOZ s9	Contact expansion or safe timer					e	3
PNOZ s10	Contact expansion					e	3
PNOZ s11	Contact expansion					e	3

Category (in accordance with EN 954-1)	Output contacts				Universal power supply 48 ... 240 VAC/DC	Housing width in mm
	Safe		Auxiliary contacts			
						
2	2	-	-	1		12.5
2	3	-	1	1		17.5
4	2	-	-	1		17.5
4	3	-	1	1	◆	22.5
4	3	-	1	1	◆	22.5
4	2	2	-	1	◆	22.5
EN 574, Type IIIC	3	-	1	1	◆	22.5
EN 574, Type IIIA	3	-	1	1	◆	22.5
Depends on base unit	4	-	1	-		17.5
Depends on base unit	3	-	-	-		17.5
Depends on base unit	4	-	1	-		17.5
Depends on base unit	2	-	-	1		12.5
Depends on base unit, Cat. 4 as timer	-	3	1	-		17.5
Depends on base unit	4	-	1	-		45.0
Depends on base unit	8	-	1	-		45.0

Technical
documentation
on PNOZsigma
safety relays:

 Webcode 0685

Online information
at www.pilz.com



► Technical details – PNOZsigma

Safety relays – PNOZsigma



Type	Supply voltage (U _B)	Outputs: Voltage/current/rating	Dimensions (H x W x D) in mm
PNOZ s1	24 VDC	DC1: 24 V/3 A/75 W	102/98 ¹⁾ x 12.5 x 120
PNOZ s2	24 VDC	DC1: 24 V/8 A/200 W	102/98 ¹⁾ x 17.5 x 120
PNOZ s3	24 VDC	DC1: 24 V/8 A/200 W	102/98 ¹⁾ x 17.5 x 120
PNOZ s4	<ul style="list-style-type: none"> ▶ 24 VDC ▶ 48 ... 240 VAC/DC 	DC1: 24 V/8 A/200 W, DC1: 24 V/6 A/150 W	102/98 ¹⁾ x 22.5 x 120
PNOZ s4.1	<ul style="list-style-type: none"> ▶ 24 VDC ▶ 48 ... 240 VAC/DC 	DC1: 24 V/6 A/150 W	102/98 ¹⁾ x 22.5 x 120
PNOZ s5	<ul style="list-style-type: none"> ▶ 24 VDC ▶ 48 ... 240 VAC/DC 	DC1: 24 V/6 A/150 W	102/98 ¹⁾ x 22.5 x 120
PNOZ s6	<ul style="list-style-type: none"> ▶ 24 VDC ▶ 48 ... 240 VAC/DC 	DC1: 24 V/8 A/200 W, DC1: 24 V/6 A/150 W	102/98 ¹⁾ x 22.5 x 120
PNOZ s6.1	<ul style="list-style-type: none"> ▶ 24 VDC ▶ 48 ... 240 VAC/DC 	DC1: 24 V/8 A/200 W, DC1: 24 V/6 A/150 W	102/98 ¹⁾ x 22.5 x 120

Features	Order number	
	Spring-loaded terminals	Plug-in screw terminals
<ul style="list-style-type: none"> ▶ 1-channel operation ▶ Manual/automatic reset 	24 VDC 751 101	24 VDC 750 101
<ul style="list-style-type: none"> ▶ 1-channel operation ▶ Monitored reset ▶ Manual/automatic reset ▶ Safe separation 	24 VDC 751 102	24 VDC 750 102
<ul style="list-style-type: none"> ▶ 1 and 2-channel operation ▶ Detection of shorts across contacts ▶ Monitored reset ▶ Manual/automatic reset ▶ Start-up testing 	24 VDC 751 103	24 VDC 750 103
<ul style="list-style-type: none"> ▶ 1 and 2-channel operation ▶ Detection of shorts across contacts ▶ Monitored reset ▶ Manual/automatic reset ▶ Start-up testing 	<ul style="list-style-type: none"> ▶ 24 VDC 751 104 ▶ 48 ... 240 VAC/DC 751 134 	<ul style="list-style-type: none"> ▶ 24 VDC 750 104 ▶ 48 ... 240 VAC/DC 750 134
<ul style="list-style-type: none"> ▶ 1 and 2-channel operation ▶ Detection of shorts across contacts ▶ Monitored reset ▶ Manual/automatic reset ▶ Start-up testing ▶ 3 safe, diverse safety contacts ▶ Approved in accordance with the standard EN 50156-1 for electrical equipment for furnaces 	<ul style="list-style-type: none"> ▶ 24 VDC 751 124 ▶ 48 ... 240 VAC/DC 751 154 	<ul style="list-style-type: none"> ▶ 24 VDC 750 124 ▶ 48 ... 240 VAC/DC 750 154
<ul style="list-style-type: none"> ▶ 1 and 2-channel operation ▶ Detection of shorts across contacts ▶ Monitored reset ▶ Manual/automatic reset ▶ Start-up testing ▶ Timer functions: delay-on de-energisation ▶ Time range: 0 ... 300 s 	<ul style="list-style-type: none"> ▶ 24 VDC 751 105 ▶ 48 ... 240 VAC/DC 751 135 	<ul style="list-style-type: none"> ▶ 24 VDC 750 105 ▶ 48 ... 240 VAC/DC 750 135
<ul style="list-style-type: none"> ▶ 2-channel operation ▶ Detection of shorts across contacts 	<ul style="list-style-type: none"> ▶ 24 VDC 751 106 ▶ 48 ... 240 VAC/DC 751 136 	<ul style="list-style-type: none"> ▶ 24 VDC 750 106 ▶ 48 ... 240 VAC/DC 750 136
<ul style="list-style-type: none"> ▶ 2-channel operation ▶ Detection of shorts across contacts 	<ul style="list-style-type: none"> ▶ 24 VDC 751 126 ▶ 48 ... 240 VAC/DC 751 156 	<ul style="list-style-type: none"> ▶ 24 VDC 750 126 ▶ 48 ... 240 VAC/DC 750 156



Technical documentation on PNOZsigma safety relays:

Webcode 0685

Online information at www.pitz.com

¹⁾ Height with spring-loaded terminals/plug-in screw terminals
²⁾ Only for PNOZ s4.1



► Technical details – PNOZsigma

Safety relays – PNOZsigma



Type	Supply voltage (U _B)	Outputs: Voltage/current/rating	Dimensions (H x W x D) in mm
PNOZ s7	24 VDC	DC1: 24 V/8 A/200 W	102/98 ¹⁾ x 17.5 x 120
PNOZ s7.1	24 VDC	DC1: 24 V/8 A/200 W	102/98 ¹⁾ x 17.5 x 120
PNOZ s7.2	24 VDC	DC1: 24 V/8 A/200 W	102/98 ¹⁾ x 17.5 x 120
PNOZ s8	24 VDC	DC1: 24 V/3 A/75 W	102/98 ¹⁾ x 12.5 x 120
PNOZ s9	24 VDC	DC1: 24 V/8 A/200 W	102/98 ¹⁾ x 17.5 x 120
PNOZ s10	24 VDC	DC1: 24 V/12 A/300 W	102/98 ¹⁾ x 45.0 x 120
PNOZ s11	24 VDC	DC1: 24 V/8 A/200 W	102/98 ¹⁾ x 45.0 x 120

Features	Order number	
	Spring-loaded terminals	Plug-in screw terminals
▶ Safe separation	24 VDC 751 107	24 VDC 750 107
▶ Cascading module for connection to PNOZ s7.2 ▶ Safe separation of safety contacts ▶ LEDs for input and switch status ▶ Can also be used with other safety control devices, without a PNOZsigma base unit: one input circuit affects the output relays	24 VDC 751 167	24 VDC 750 167
▶ Contact expansion module in conjunction with PNOZ s7.1	24 VDC 751 177	24 VDC 750 177
-	24 VDC 751 108	24 VDC 750 108
▶ Safe separation ▶ Timer functions: delay-on energisation, delay-on de-energisation, pulsing, retriggerable ▶ Time range: 0 ... 300 s	24 VDC 751 109	24 VDC 750 109
▶ Safe separation	24 VDC 751 110	24 VDC 750 110
▶ Safe separation	24 VDC 751 111	24 VDC 750 111

¹⁾ Height with spring-loaded terminals/plug-in screw terminals



Technical documentation on PNOZsigma safety relays:

Webcode 0685

Online information at www.pitz.com



▶ PNOZelog safety relays

Extended diagnostics, easy to link

Ideal for monitoring up to four safety functions, the innovative PNOZelog product range combines the experience of the electromechanical safety relays with the benefits of modern electronics. Wear-resistance, safety, long service life and high availability ensure it is cost-effective to use. PNOZelog is also easy to link through logic AND/OR operations. Diagnostics on the PNOZelog have been extended. Power-up tests, self-checking and runtime tests guarantee maximum safety.

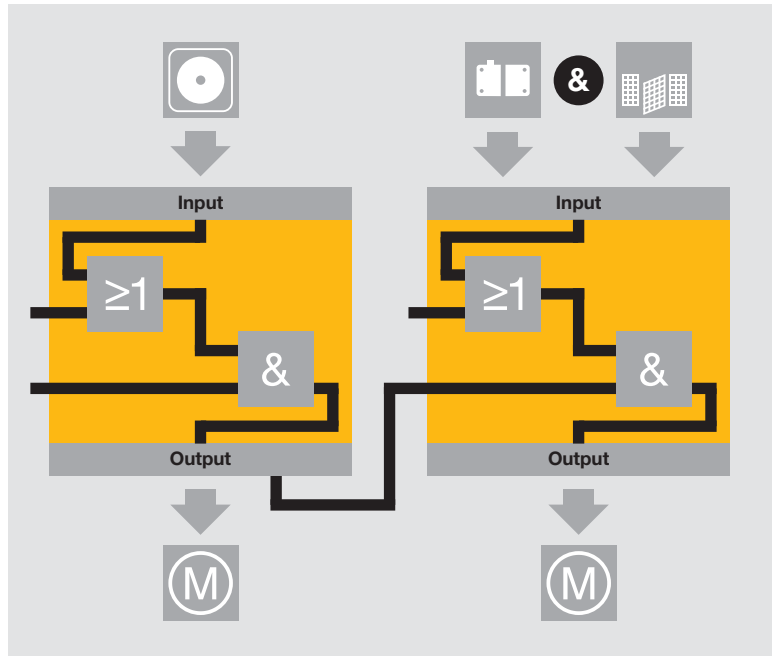

Less wiring due to linkable outputs.



PNOZelog can be linked through logic AND/OR operations.

Complete safety functions through logic function links

Units in the PNOZelog product range can be linked via logic operations to form complete safety functions. AND/OR operations are both available. The use of logic functions means that the output requires no additional wiring. Both outputs on the PNOZelog units are available. As many units as necessary can be connected in series – ideal for monitoring up to four safety functions.



**“2-in-1” –
The bifunctional PNOZelog**

Do you require E-STOP or safety gate monitoring within a compact safety unit? Monitor two safety functions simultaneously with just a single unit. You save on wiring. With a width of just 22.5 mm, the space requirement within the control cabinet is reduced to a minimum. Maximum functionality

is achieved through the internal logic AND operation. Each safety function has a separate signal output.

- ▶ PNOZ e5.11p simultaneously monitors an E-STOP/safety gate combination or two safety gates
- ▶ The PNOZ e5.13p can also be connected to the PSENmag safety switches

Your benefits at a glance

- ▶ Less wiring thanks to simple logic operations (AND/OR)
- ▶ High availability thanks to extended diagnostics
- ▶ Consistent use of semiconductor technology means no maintenance is necessary – there are no malfunctions due to contact welding, contamination, bounce or burning
- ▶ Continuous self-checks provide the highest level of safety – fault detection is not linked to the on/off cycle
- ▶ Long service life, even with frequent operations or cyclical functions
- ▶ Safe switching operations even on the smallest of loads
- ▶ Rapid commissioning thanks to plug-in terminals; no additional tools are required
- ▶ Complete solution comprising evaluation devices, compatible sensor technology and control and signal devices

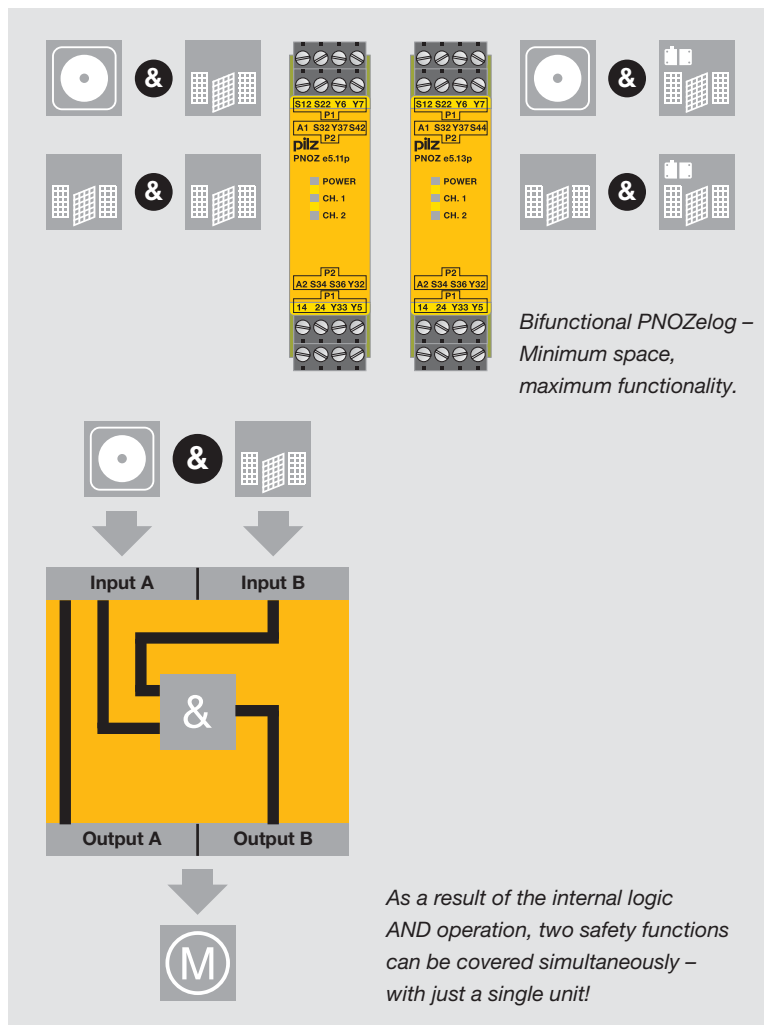

Keep up-to-date
on PNOZelog
safety relays:

Webcode 0209

Online information
at www.pilz.com



▶ Selection guide – PNOZelog

Safety relays – PNOZelog

Type	Application					Performance Level (PL) – EN ISO 13849-1	Safety Integrity Level (SIL) CL – claim limit in accordance with IEC 62061
PNOZ e1p	◆	◆	◆			e	3
PNOZ e1.1p	◆	◆	◆			e (d) ¹⁾	3
PNOZ e1vp	◆	◆	◆			e (d) ¹⁾	3
PNOZ e2.1p				◆		e (d) ¹⁾	3
PNOZ e2.2p				◆		e (d) ¹⁾	3
PNOZ e3.1p		◆				e (d) ¹⁾	3
PNOZ e3vp		◆				e (d) ¹⁾	3
PNOZ e4.1p					◆	d	2
PNOZ e4vp					◆	d	2
PNOZ e5.11p	◆	◆				e (d) ¹⁾	3
PNOZ e5.13p	◆	◆				e (d) ¹⁾	3
PNOZ e6.1p	◆	◆	◆			e (d) ¹⁾	3
PNOZ e6vp	◆	◆	◆			e (d) ¹⁾	3

Category (in accordance with EN 954-1)			Semiconductor outputs			Relay outputs		Logic connection	
			Safe		Non-safe	Safe		&	≥1
2	3	4							
◆	◆	◆	2		1	-	-		
◆	◆	◆	2		1	-	-	◆	◆
◆	◆	◆	2	◆	1	-	-	◆	◆
EN 574, Type IIIC	EN 574, Type IIIC	EN 574, Type IIIC	2		1	-	-	◆	◆
EN 574, Type IIIA	EN 574, Type IIIA	EN 574, Type IIIA	2		1	-	-	◆	◆
◆	◆	◆	2		1	-	-	◆	◆
◆	◆	◆	2	◆	1	-	-	◆	◆
	◆		2		1	-	-	◆	◆
	◆		2	◆	1	-	-	◆	◆
◆	◆		2		2	-	-	◆ ²⁾	
◆	◆		2		2	-	-	◆ ²⁾	
◆	◆	◆	2		1	4	-	◆	◆
◆	◆	◆	2	◆	1	4	-	◆	◆

¹⁾ without (with) logic AND connection

²⁾ Also AND-linked internally

Technical
documentation
on PNOZelog
safety relays:

Webcode 0685

Online information
at www.pilz.com



► Technical details – PNOZelog

Safety relays – PNOZelog



PNOZ e1.1p



PNOZ e2.1p



PNOZ e3.1p

Type	Application range	Outputs	Outputs: Voltage/ current/rating
PNOZ e1p	E-STOP, safety gate and light beam monitoring	Using semiconductor technology: <ul style="list-style-type: none"> ▶ 2 safety outputs ▶ 1 auxiliary output, can be switched to a diagnostic output ▶ 2 test pulse outputs 	24 VDC/ 2 A/50 W
PNOZ e1.1p	E-STOP, safety gate and light beam monitoring	Using semiconductor technology: <ul style="list-style-type: none"> ▶ 2 safety outputs ▶ 1 auxiliary output, can be switched to a diagnostic output ▶ 2 test pulse outputs 	24 VDC/ 2 A/50 W
PNOZ e1vp	E-STOP, safety gate and light beam monitoring	Using semiconductor technology: <ul style="list-style-type: none"> ▶ 2 safety outputs delayed/instantaneous, delay-on de-energisation selectable ▶ 1 auxiliary output, can be switched to a diagnostic output ▶ 2 test pulse outputs 	24 VDC/ 2 A/50 W
PNOZ e2.1p PNOZ e2.2p	PNOZ e2.1p: In accordance with EN 574, Requirement class IIIC; PNOZ e2.2p: In accordance with EN 574, Requirement class IIIA: Two-hand monitoring	Using semiconductor technology: <ul style="list-style-type: none"> ▶ 2 safety outputs ▶ 1 auxiliary output, can be switched to a diagnostic output ▶ 2 test pulse outputs 	24 VDC/ 2 A/50 W
PNOZ e3.1p	Safety gate monitoring	Using semiconductor technology: <ul style="list-style-type: none"> ▶ 2 safety outputs ▶ 1 auxiliary output, can be switched to a diagnostic output ▶ 2 test pulse outputs 	24 VDC/ 2 A/50 W
PNOZ e3vp	Safety gate monitoring	Using semiconductor technology: <ul style="list-style-type: none"> ▶ 2 safety outputs delayed/instantaneous, delay-on de-energisation selectable ▶ 1 auxiliary output, can be switched to a diagnostic output ▶ 2 test pulse outputs 	24 VDC/ 2 A/50 W

Common features

- ▶ Supply voltage (U_B): 24 VDC
- ▶ Dimensions (H x W x D): 101/94¹⁾ x 22.5 x 121 mm

Features	Order number	
	Spring-loaded terminals	Plug-in screw terminals
<ul style="list-style-type: none"> ▶ Evaluation device for non-contact, coded safety switches PSENcode ▶ Monitored or automatic reset can be selected ▶ Selectable monitoring of shorts across contacts 	784 130	774 130
<ul style="list-style-type: none"> ▶ Evaluation device for non-contact, coded safety switches PSENcode ▶ Monitored or automatic reset can be selected ▶ One AND and one OR input for logic AND/OR connections between several PNOZelog units ▶ Selectable monitoring of shorts across contacts 	784 133	774 133
<ul style="list-style-type: none"> ▶ Evaluation device for non-contact, coded safety switches PSENcode ▶ Monitored or automatic reset can be selected ▶ One AND and one OR input for logic AND/OR connections between several PNOZelog units ▶ Selectable monitoring of shorts across contacts 	<ul style="list-style-type: none"> ▶ 10 s 784 131 ▶ 300 s 784 132 	<ul style="list-style-type: none"> ▶ 10 s 774 131 ▶ 300 s 774 132
<ul style="list-style-type: none"> ▶ One AND and one OR input for logic AND/OR connections between several PNOZelog units ▶ Shorts across contacts are monitored via two test pulse outputs ▶ Status display ▶ Feedback loop for monitoring external contactors 	<ul style="list-style-type: none"> ▶ PNOZ e2.1p 784 136 ▶ PNOZ e2.2p 784 135 	<ul style="list-style-type: none"> ▶ PNOZ e2.1p 774 136 ▶ PNOZ e2.2p 774 135
<ul style="list-style-type: none"> ▶ Evaluation device for position switches and for non-contact, magnetic safety switches PSENmag (Series 2) ▶ Monitored or automatic reset can be selected ▶ One AND and one OR input for logic AND/OR connections between several PNOZelog units ▶ Selectable monitoring of shorts across contacts 	784 139	774 139
<ul style="list-style-type: none"> ▶ Evaluation device for position switches and for non-contact, magnetic safety switches PSENmag (Series 2) ▶ Monitored or automatic reset can be selected ▶ One AND and one OR input for logic AND/OR connections between several PNOZelog units ▶ Selectable monitoring of shorts across contacts 	<ul style="list-style-type: none"> ▶ 10 s 784 137 ▶ 300 s 784 138 	<ul style="list-style-type: none"> ▶ 10 s 774 137 ▶ 300 s 774 138



Technical documentation on PNOZelog safety relays:

Webcode 0685







Online information at www.pilz.com

¹⁾ Height with spring-loaded terminals/plug-in screw terminals

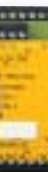

► Technical details – PNOZelog

Safety relays – PNOZelog

Type	Application range	Outputs	Outputs: Voltage/ current/rating
 PNOZ e4.1p	Evaluation device for safety mats	Using semiconductor technology: <ul style="list-style-type: none"> ▶ 2 safety outputs ▶ 1 auxiliary output, can be switched to a diagnostic output ▶ 2 test pulse outputs 	24 VDC/ 2 A/50 W
 PNOZ e4vp	Evaluation device for safety mats	Using semiconductor technology: <ul style="list-style-type: none"> ▶ 2 safety outputs delayed/instantaneous, delay-on de-energisation selectable ▶ 1 auxiliary output, can be switched to a diagnostic output ▶ 2 test pulse outputs 	24 VDC/ 2 A/50 W
 PNOZ e5.11p	Combined unit for monitoring E-STOP relay and/or safety gate, AND-linked internally	Using semiconductor technology: <ul style="list-style-type: none"> ▶ 2 safety outputs ▶ 2 auxiliary outputs 	24 VDC/ 1.5 A/40 W
 PNOZ e5.13p	Combined unit for monitoring E-STOP relay and/or safety gate, AND-linked internally	Using semiconductor technology: <ul style="list-style-type: none"> ▶ 2 safety outputs ▶ 2 auxiliary outputs 	24 VDC/ 1.5 A/40 W
 PNOZ e6.1p	E-STOP, safety gate and light beam monitoring	Using semiconductor technology: <ul style="list-style-type: none"> ▶ 2 safety outputs ▶ 1 auxiliary output, can be switched to a diagnostic output ▶ 2 test pulse outputs Relay outputs: ▶ 4 safety contacts (N/O)	Outputs using semiconductor technology: 24 VDC/4 A/50 W Relay outputs: DC1: 24 V/6 A/150 W
 PNOZ e6vp	E-STOP, safety gate and light beam monitoring	Using semiconductor technology: <ul style="list-style-type: none"> ▶ 2 safety outputs delayed/instantaneous, delay-on de-energisation selectable ▶ 1 auxiliary output, can be switched to a diagnostic output ▶ 2 test pulse outputs Relay outputs: ▶ 4 safety contacts (N/O)	Outputs using semiconductor technology: 24 V/4 A/50 W Relay outputs: DC1: 24 V/6 A/150 W

Common features

- ▶ Supply voltage (U_B): 24 VDC
- ▶ Dimensions (H x W x D): 101/94¹⁾ x 22.5 x 121 mm,
PNOZ e6.1p and PNOZ e6vp: 101/94¹⁾ x 45 x 121 mm

Features	Order number	
	Spring-loaded terminals	Plug-in screw terminals
<ul style="list-style-type: none"> ▶ Used to connect Mayser safety mats, type: SM/BK ▶ Suitable for controlling PSS/SafetyBUS p/PNOZmulti ▶ One AND and one OR input for logic AND/OR connections between several PNOZelog units ▶ With or without reset function 	784 180	774 180
<ul style="list-style-type: none"> ▶ Used to connect Mayser safety mats, type: SM/BK ▶ Suitable for controlling PSS/SafetyBUS p/PNOZmulti ▶ One AND and one OR input for logic AND/OR connections between several PNOZelog units ▶ With or without reset function 	10 s 784 181	10 s 774 181
<ul style="list-style-type: none"> ▶ 2 safety functions in one unit, AND-linked internally ▶ Evaluation device for position switches and non-contact, coded safety switches PSENcode ▶ One AND input for logic AND connections between several PNOZelog units ▶ Monitored or automatic reset can be selected 	784 190	774 190
<ul style="list-style-type: none"> ▶ 2 safety functions in one unit, AND-linked internally ▶ Evaluation device for position switches, non-contact safety switches PSENcode and PSENmag (Series 2.X) ▶ Monitored or automatic reset can be selected ▶ One AND input for logic AND connections between several PNOZelog units 	784 191	774 191
<ul style="list-style-type: none"> ▶ Connection option for E-STOP pushbuttons, safety gate limit switches, reset buttons, safety mats and safe edges made by Haake, proximity switch evaluation devices ▶ Monitored or automatic reset can be selected ▶ One AND and one OR input for logic AND/OR connections between several PNOZelog units ▶ Selectable monitoring of shorts across contacts 	784 192	774 192
<ul style="list-style-type: none"> ▶ Connection option for E-STOP pushbuttons, safety gate limit switches, reset buttons, safety mats and safe edges made by Haake, proximity switch evaluation devices ▶ Monitored or automatic reset can be selected ▶ One AND and one OR input for logic AND/OR connections between several PNOZelog units ▶ Selectable monitoring of shorts across contacts 	784 193	774 193



Technical documentation on PNOZelog safety relays:

Webcode 0685

Online information at www.pitz.com

¹⁾ Height with spring-loaded terminals/plug-in screw terminals



▶ PNOZpower safety relays

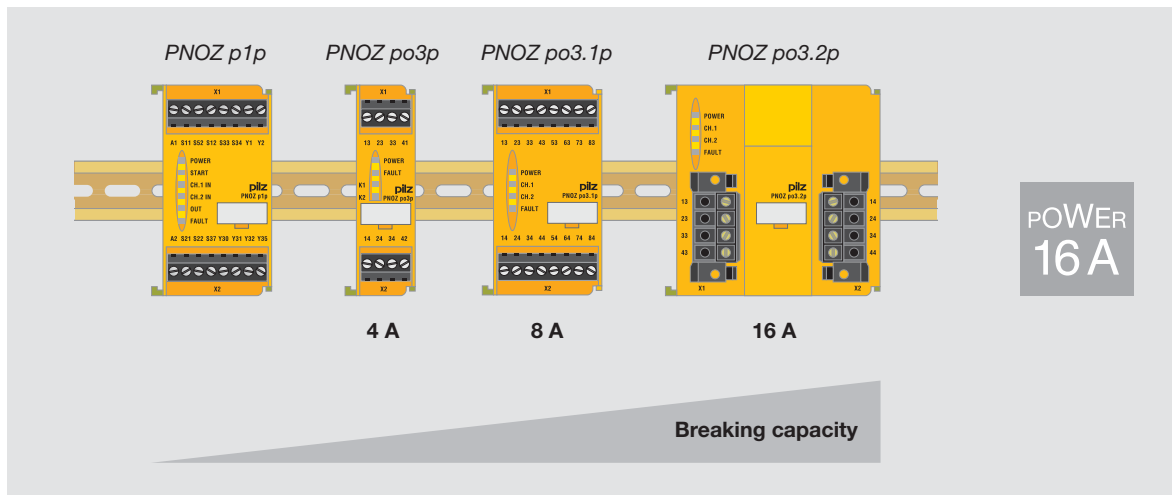

Switching high loads safely

PNOZpower safety relays are suitable for monitoring E-STOPS, safety gates and light beam devices. PNOZpower can switch currents of up to 16 A AC/DC per contact. An overall breaking capacity of 40 A is available per module. In each case, external contactors and contactor combinations are no longer required.

The control circuit and main circuit are switched with one safety relay. The EC type examination is valid for the whole safety circuit.

Modular and flexible

The base module processes the inputs, the output modules are specifically matched to the respective load. The number

and capacity of the required safety contacts can be scaled, depending on the application. A maximum of five modules can be connected to the base unit. Modules are wired to the base unit via an internal bus system.



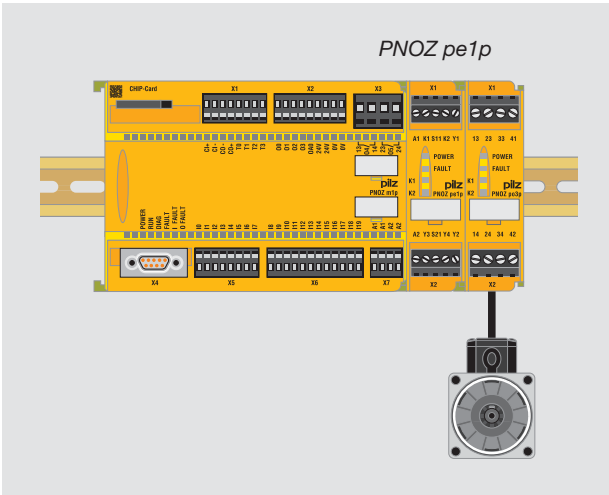

Volt-free switching with the PNOZ pe1p control module

In conjunction with at least one expansion module from the PNOZpower-range, the PNOZ pe1p control module safely shuts down motors or supply voltages on valves and contactors.

The PNOZ pe1p can be driven via:

- ▶ The safety relays PNOZelog, PNOZ X
- ▶ The configurable control system PNOZmulti
- ▶ PSS programmable control systems
- ▶ The safe bus system SafetyBUS p

Benefit to you:
Volt-free switching up to 16 A.

Your benefits at a glance

- ▶ External contactor combinations and their respective wiring are no longer required, saving costs, space and commissioning time
- ▶ Diagnostics via LED: operating and fault status can be scanned on each module, resulting in fewer downtimes
- ▶ Plug-in connection terminals: pre-wired and easy to exchange if there is a fault
- ▶ Redundant load switching
- ▶ Scalable and flexible by selecting compatible modules – you only pay for the functions that you actually use
- ▶ Complete solution comprising evaluation devices, compatible sensor technology and control and signal devices

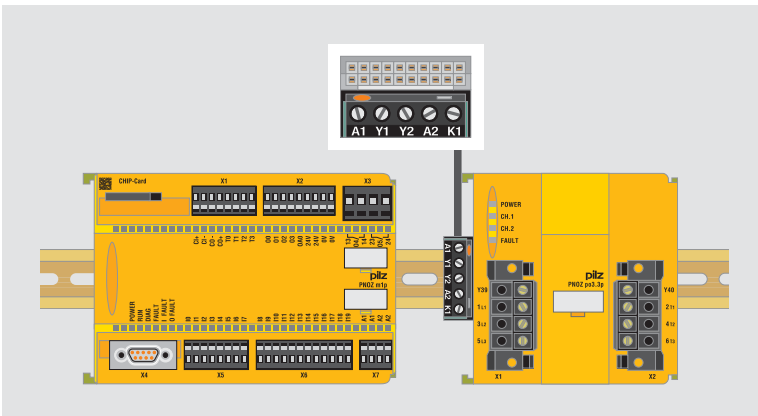

PNOZpower safety relays and the PNOZmulti configurable control system are easily combined using the coupling connector PNOZ pe2p.

Connection to PNOZmulti

Specially developed for connection to the PNOZmulti configurable control system, PNOZpower units can be docked via the coupling connector PNOZ pe2p.

Keep up-to-date on PNOZpower safety relays:





Webcode 0245

Online information at www.pilz.com



▶ Selection guide – PNOZpower

Safety relays – PNOZpower

Type	Scope	Application				Performance Level (PL) – EN ISO 13849-1
						
PNOZ p1p	Base unit	◆	◆	◆		e
PNOZ p1vp	Base unit, delayed	◆	◆	◆	◆	e (d) ¹⁾
PNOZ pe1p	Control module	For control via safety contacts or safe semiconductor outputs				e
PNOZ pe2p	Bus interface	Coupling connector for connecting PNOZpower expansion modules to a higher-level control system				e
PNOZ pps1p	Power supply	-				-

Safety relays – PNOZpower

Type	Output contacts		Performance Level (PL) – EN ISO 13849-1
	Safe 	Non-safe 	
PNOZ po3p	3	1	e
PNOZ po3.1p	8	-	e
PNOZ po3.2p	4	-	e
PNOZ po3.3p	3	-	e
PNOZ po4p	4	-	e

Safety Integrity Level (SIL) CL – claim limit in accordance with IEC 62061	Number of expansion modules	Supply voltage	Housing width in mm
3	Min. 1, max. 4 expansion modules	24 VDC	45.0
3	Min. 1, max. 8 expansion modules (max. 4 delayed and 4 instantaneous)	24 VDC	45.0
3	Min. 1, max. 4 expansion modules	24 VDC	22.5
3	Min. 1, max. 6 expansion modules	24 VDC	23.5
-	-	100 ... 240 VAC	45.0

¹⁾ Value applies for instantaneous (delayed) safety contacts

Safety Integrity Level (SIL) CL – claim limit in accordance with IEC 62061	Outputs: Voltage/current/rating			Housing width in mm
	AC1	AC3	DC1:	
3	240 V/4 A/960 VA	-	24 V/4 A/96 W	22.5
3	240 V/8 A/2 000 VA	-	24 V/8 A/200 W	45.0
3	240 V/16 A/4 000 VA	-	24 V/16 A/400 W	90.0
3	240 V/16 A/4 000 VA 400 V/10 A/4 000 VA 500 V/8 A/4 000 VA	240 V/3.0 kW 400 V/5.5 kW 500 V/4.0 kW	24 V/16 A/400 W	90.0
3	240 V/4 A/960 VA	-	24 V/4 A/96 W	22.5

Technical documentation on PNOZpower safety relays:

 Webcode 0685

Online information at www.pilz.com



► Technical details – PNOZpower

Safety relays – PNOZpower



PNOZ p1p

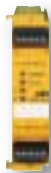

PNOZ pe1p



PNOZ pe2p

Type	Scope	Supply voltage	Dimensions (H x W x D) in mm
PNOZ p1p	Base unit	24 VDC	94 x 45 x 135
PNOZ p1vp	Base unit, delayed	24 VDC	94 x 45 x 135
PNOZ pe1p	Control module	24 VDC	94 x 22.5 x 135
PNOZ pe2p	Bus interface	24 VDC	22 x 23.5 x 29

Features	Order number
	Plug-in screw terminals
<ul style="list-style-type: none"> ▶ 2-channel operation with or without detection of shorts across contacts ▶ Monitored or automatic reset can be selected ▶ 2 semiconductor outputs ▶ Connection between PNOZ p1p and expansion modules via PNOZpower bus, using jumpers on the back of the unit 	773 300
<ul style="list-style-type: none"> ▶ 2-channel operation with or without detection of shorts across contacts ▶ Monitored or automatic reset can be selected ▶ 2 semiconductor outputs ▶ Delay time can be selected via rotary switch and potentiometer ▶ Connection between PNOZ p1vp and expansion modules via PNOZpower bus, using jumpers on the back of the unit 	<ul style="list-style-type: none"> ▶ 30 s773 950 ▶ 300 s773 951
<ul style="list-style-type: none"> ▶ 1-channel operation, without detection of shorts across contacts ▶ 2-channel operation, with or without detection of shorts across contacts ▶ Expansion module control output connected to the PNOZpower bus ▶ Connection between PNOZ pe1p and expansion modules via PNOZpower bus, using jumpers on the back of the unit ▶ Status indicator for output relay, supply voltage and fault ▶ Connection for feedback loop 	773 900
<ul style="list-style-type: none"> ▶ Driven via safety contacts or safe semiconductor outputs ▶ 1-channel operation, without detection of shorts across contacts ▶ Output connected to PNOZpower bus ▶ Connection between PNOZ pe2p and expansion modules via PNOZpower bus 	779 125



Technical documentation on PNOZpower safety relays:

 Webcode 0685

Online information at www.pilz.com



► Technical details – PNOZpower

Safety relays – PNOZpower



PNOZ po3p



PNOZ po3.2p



PNOZ pps1p

Type	Scope	Inputs/outputs	Supply voltage
PNOZ po3p/ PNOZ po4p	Expansion modules	<ul style="list-style-type: none"> ▶ PNOZ po3p: <ul style="list-style-type: none"> - 3 safety contacts (N/O) - 1 auxiliary contact (N/C) ▶ PNOZ po4p: <ul style="list-style-type: none"> - 4 safety contacts (N/O) 	Via PNOZpower bus
PNOZ po3.1p	Expansion module	8 safety contacts (N/O)	Via PNOZpower bus
PNOZ po3.2p	Expansion module	4 safety contacts (N/O)	Via PNOZpower bus
PNOZ po3.3p	Expansion module	3 safety contacts (N/O)	Via PNOZpower bus
PNOZ pps1p	Power supply	-	100 ... 240 VAC/DC

Outputs: Voltage/current/rating	Dimensions (H x W x D) in mm	Features	Order number Plug-in screw terminals
AC1: 240 V/4 A/960 VA DC1: 24 V/4 A/96 W	94 x 22.5 x 135	<ul style="list-style-type: none"> ▶ 2-channel operation with the ability to detect short circuits via the base unit ▶ LEDs for switch status of channels 1/2, supply voltage and fault 	<ul style="list-style-type: none"> ▶ PNOZ po3p.....773 634 ▶ PNOZ po4p.....773 635
AC1: 240 V/8 A/2 000 VA DC1: 24 V/8 A/200 W	94 x 45 x 135	<ul style="list-style-type: none"> ▶ 2-channel operation with the ability to detect short circuits via the base unit ▶ LEDs for switch status of channels 1/2, supply voltage and fault 	773 630
AC1: 240 V/16 A/4 000 VA, 400 V/10 A/4 000 VA DC1: 24 V/16 A/400 W	94 x 90 x 144	<ul style="list-style-type: none"> ▶ 2-channel operation with the ability to detect short circuits via the base unit ▶ LEDs for switch status of channels 1/2, supply voltage and fault 	773 631
AC1: 240 V/16 A/4 000 VA; 400 V/10 A/4 000 VA; 500 V/8 A/4 000 VA AC3: 240 V/3 kW; 400 V/5.5 kW; 500 V/4 kW DC1: 24 V/16 A/400 W	94 x 90 x 144	<ul style="list-style-type: none"> ▶ 2-channel operation with the ability to detect short circuits via the base unit ▶ Suitable for safety-related switching of loads with utilisation category AC3 (e.g. motor) ▶ External start/stop input for non-safety-related load switching ▶ LEDs for switch status of channels 1/2, supply voltage and fault 	773 632
-	94 x 45 x 135	<ul style="list-style-type: none"> ▶ Galvanic isolation ▶ Short circuit-proof ▶ 24 VDC at the plug-in connector on the back of the unit for the PNOZpower bus and at the terminals ▶ LEDs for supply voltage, output voltage and fault 	773 200



Technical documentation on PNOZpower safety relays:

Webcode 0685

Online information at www.pilz.com



Product range
PNOZmulti

▶ PNOZ multi configurable control system –

Ingeniously simple, simply ingenious

The PNOZmulti configurable safety system is multifunctional, freely configurable and tailor-made for use in many areas of mechanical engineering. Safety functions such as emergency stop, safety gates, light beam devices, two-hand control and many more are monitored safely. PNOZmulti can also be used to perform standard control functions economically. Instead of wiring, the safety circuit is easily generated on the PC using an intuitive configuration tool. The configuration is stored on a chip card and is downloaded to the PNOZmulti base unit.



Simply order the demo CD-ROM – you'll be amazed.

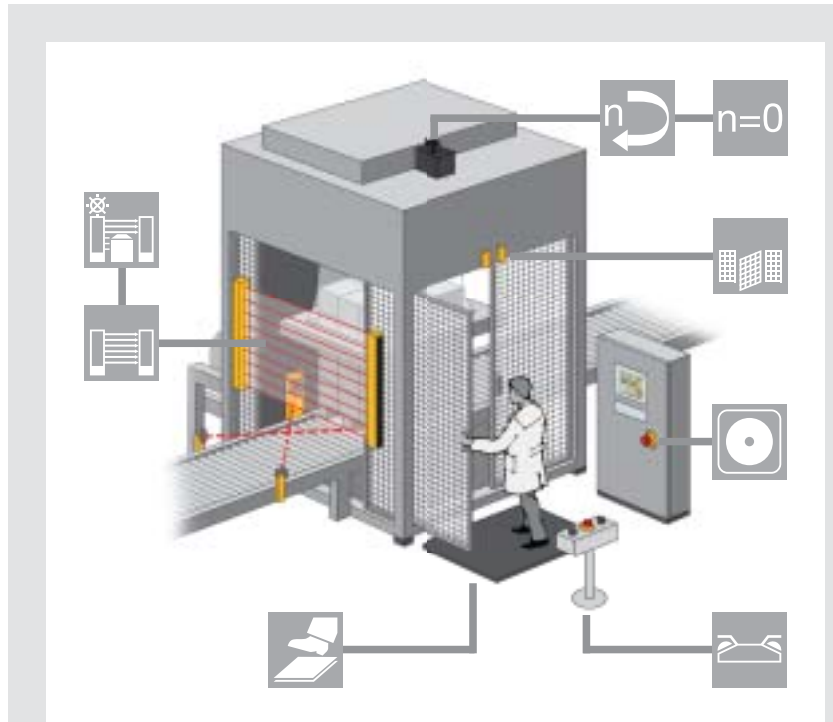

Many functions – one solution

The PNOZmulti product range continues to be expanded. The configuration software is ingeniously simple; it's often been copied but never been matched. The PNOZmulti Configurator is the key element for users, and the most important deciding factor for the application. New features are continuously being added to the tool, in close contact with users.

In using the PNOZmulti you're backing the original – the continual expansion of the product range safeguards your investment. Just talk to us!

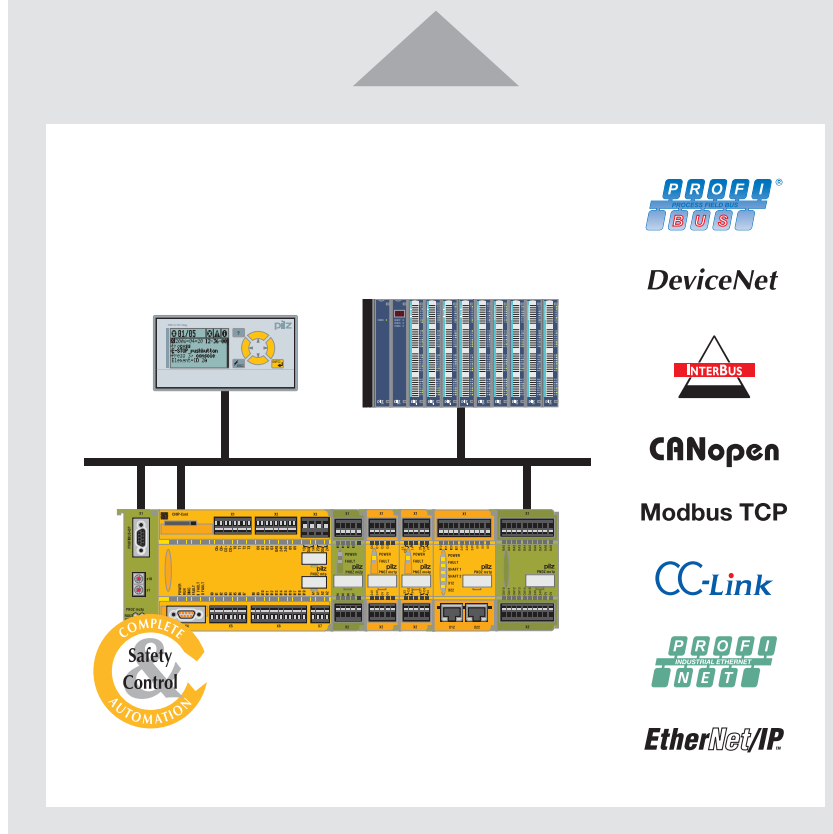

The original



As simple as a PNOZ, as flexible as a controller

If your plant expands, the PNOZmulti simply expands with it. Expansion modules are available to extend the modular system; these can be used in any combination to suit your requirements. Also available are input and output modules for both safety and standard control functions, as well as fieldbus modules for connection to all common fieldbus systems, plus speed and standstill monitors. Input and output information can easily be exchanged via the connection module PNOZ ml1p. An analogue value can be safely monitored using the safe analogue module PNOZ ma1p. Approved press blocks, muting functionalities and many other features make the PNOZmulti as simple to use as a PNOZ and as flexible as a controller.

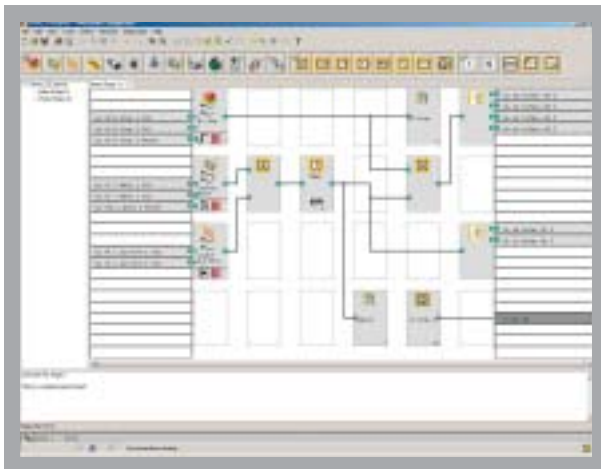
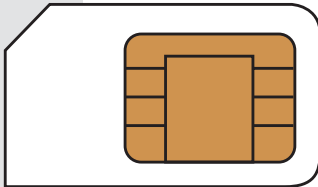

Keep up-to-date
on PNOZmulti
configurable
control systems:

 Webcode 2816

Online information
at www.pilz.com

Example: using the
PNOZmulti configurable control
system on a packaging machine.



▶ Customised application and child's play to

PNOZmulti Configurator – the original

Your safety circuit is easy to configure on the PC using the PNOZmulti Configurator. The graphics-based user interface conforms to the Windows® standard; all elements are available either as symbols or in selection menus. Configuration of the elements is based on the required machine functions and the category that needs to be achieved. Online help with documentation is available during configuration.

Configuration rather than wiring

All inputs and outputs are freely configurable and can be linked using logic elements via a simple drag and drop function. All available function, logic and output elements are available to see at a glance. Rapid commissioning and the minimal wiring work involved will convince you. With intuitive operation, the PNOZmulti is absolute child's play!

Doubly safe

Once the configuration is complete, the configuration tool checks the circuit for any errors. The completed configuration can also be certified, thereby protecting it from unwanted modifications. If the configuration has not been certified, it can be edited, modified and extended at any time by calling it up in the Configurator. The configuration can be printed out and used as documentation.

Maintenance is simple with the PNOZmulti service licence

The PNOZmulti service tool is specifically used for troubleshooting and diagnostics during service and maintenance, directly on the machine for example. The current status of the configuration is visible during operation (power-flow). Any options that can be used to modify a project are disabled.

Function elements

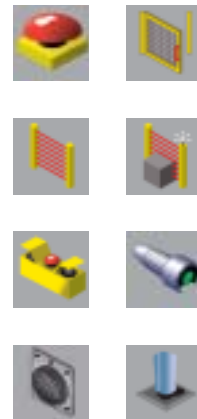

Logic elements

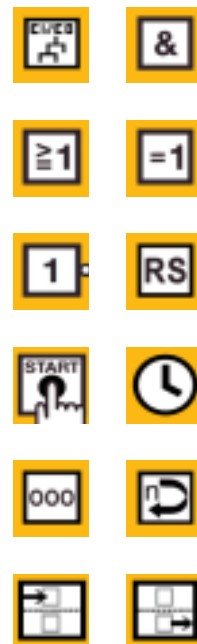

Output elements



operate

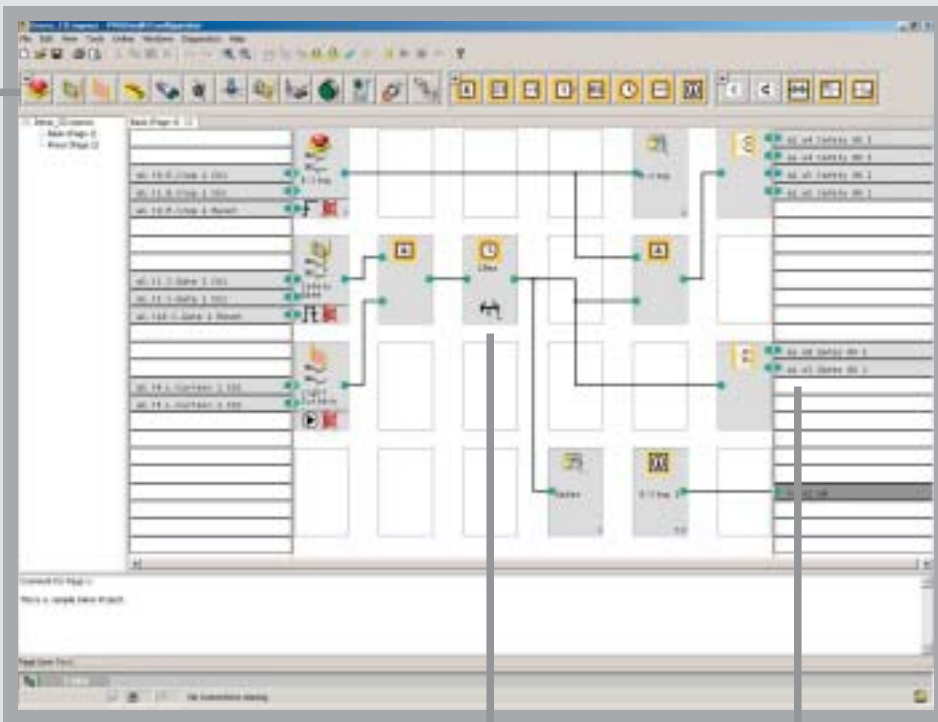

PVIS[®]
Based on Pilz
Diagnostic Concept

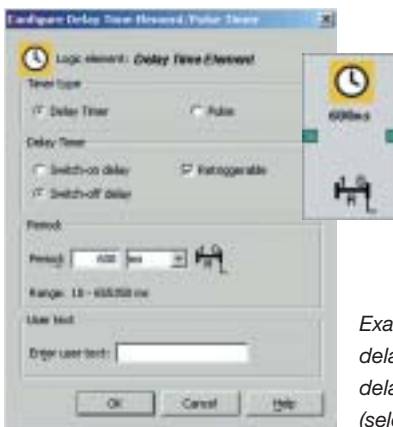

Example of a time delay element with a delay time of 600 ms (selectable).

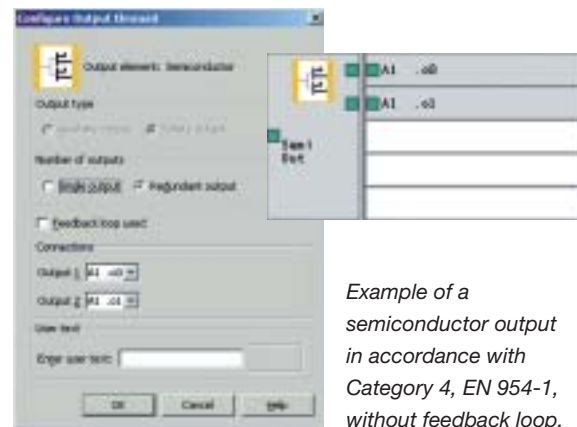

Example of a semiconductor output in accordance with Category 4, EN 954-1, without feedback loop.



► Modular and flexible

Your benefits at a glance

- ▶ Up to 40 % potential savings in all engineering phases thanks to a freely configurable, graphics configuration tool
- ▶ Ideal for covering applications of four safety functions and above
- ▶ One system to cover safety-related and standard control functions
- ▶ High potential savings thanks to simple, intuitive operation
- ▶ Subsequent modifications and adjustments to the configuration are simple to make
- ▶ Flexible to apply, as only one solution is required for Category 2, 3 or 4
- ▶ No need to draw complex circuit diagrams: simply print out your configuration
- ▶ Save costs by reducing stockholdings
- ▶ Simple, user-friendly diagnostics mean short downtimes and high plant availability
- ▶ Simple wiring means short commissioning times
- ▶ Chip card for data transfer; easy copy function is of particular interest to series users
- ▶ Saves a lot of space in the control cabinet
- ▶ Simple and economical to expand through selection of compatible modules
- ▶ Future-proof and economical thanks to the flexibility of the software and the adaptability of the hardware
- ▶ Certified worldwide
- ▶ Complete solution comprising evaluation devices, compatible sensor technology and control and signal devices

From planning to maintenance

Bring your machinery to market more quickly. Compared with conventionally wired solutions you can save up to 40 % of your time and costs – in all engineering phases – during design, configuration, commissioning, operation and maintenance.

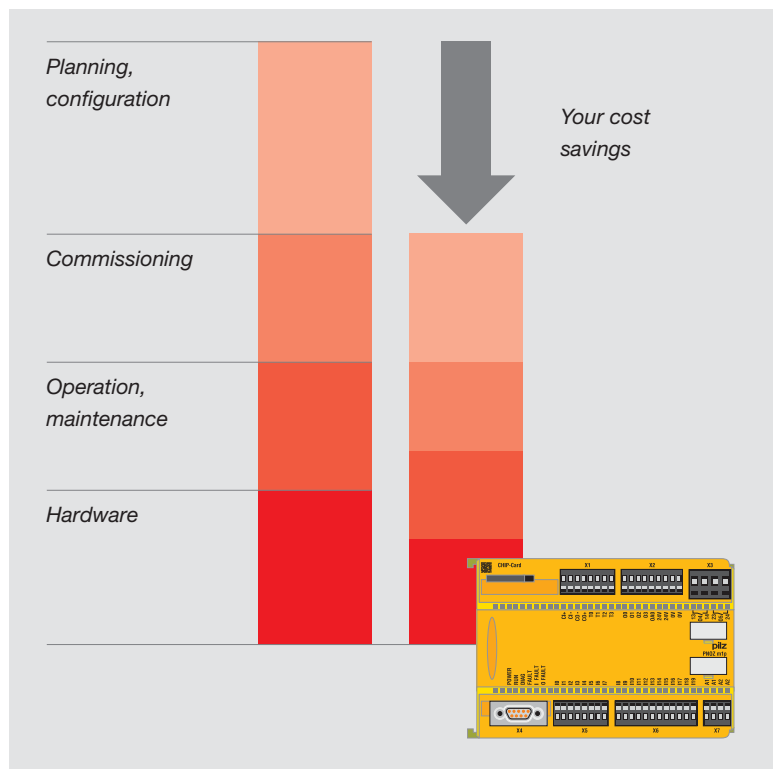

40% cost savings in all engineering phases by using PNOZmulti.

**Safe and economical
in all industries**

PNOZmulti is used in numerous applications across the widest range of industries. The intelligent dovetailing of safety-related and standard control functions, a modular concept and simple configuration mean the system can control from the simplest machine to distributed plants. PNOZmulti is so flexible that it can also be adapted to suit your application – guaranteed.

Application areas may include:

- ▶ General mechanical engineering: e.g. lathes, milling and drilling machines
- ▶ Plastics processing machines: e.g. blow moulding machines
- ▶ Laser machines: e.g. laser welding and laser punching machines
- ▶ Packaging machines: e.g. drink dispensing and palletising machines
- ▶ Forming technology: hydraulic presses, eccentric presses, press brakes, small presses and punch presses

- ▶ Robot cells: processing, welding and spraying robots
- ▶ Print and paper industry: e.g. printing, enveloping and paper machines
- ▶ Other applications e.g. in the air industry, in pleasure parks, in cablecar technology, in the automotive industry, in the pharmaceutical industry and many other sectors

Today, the PNOZmulti is the most widely used safety system in the world. We can also monitor your plant or machinery, whatever the application – just ask. Your safety is our standard.





► The basis for each application: many funct

Base unit PNOZ m0p – The compact solution ...

... for machines on which three to six safety functions are monitored. PNOZmulti is economical from just three functions. Your costs are even further reduced through simple diagnostics, for example via fieldbus modules for all common fieldbus systems. Particularly suitable for use on small machines, the PNOZ m0p manages without any expansion modules. You can enjoy all the benefits of the control system, including the complete functionality of the PNOZmulti Configurator, at an unbeatable price/performance ratio.

Ideal for three to six safety functions!

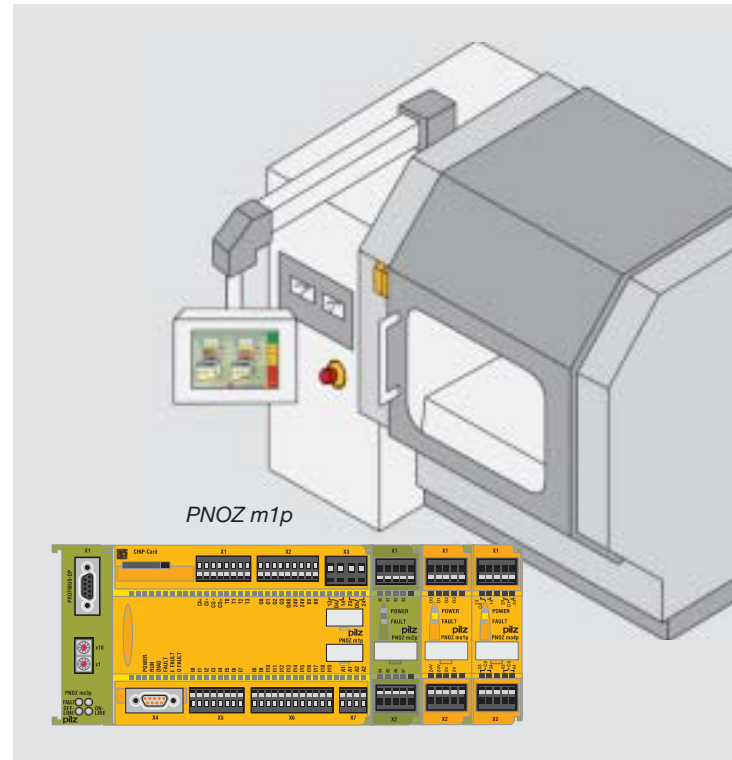

PNOZ m1p

PNOZ m1p – The all-rounder ...

... for small to average-sized machines is your ideal choice if you are using more than four safety functions. What's more, standard control functions are also monitored. It is very simple to expand and, depending on the type and number of expansion modules that are used, up to 24 safety functions can be monitored. If you then take advantage of the cascading function as well, there are almost no limits for the application of the PNOZmulti.

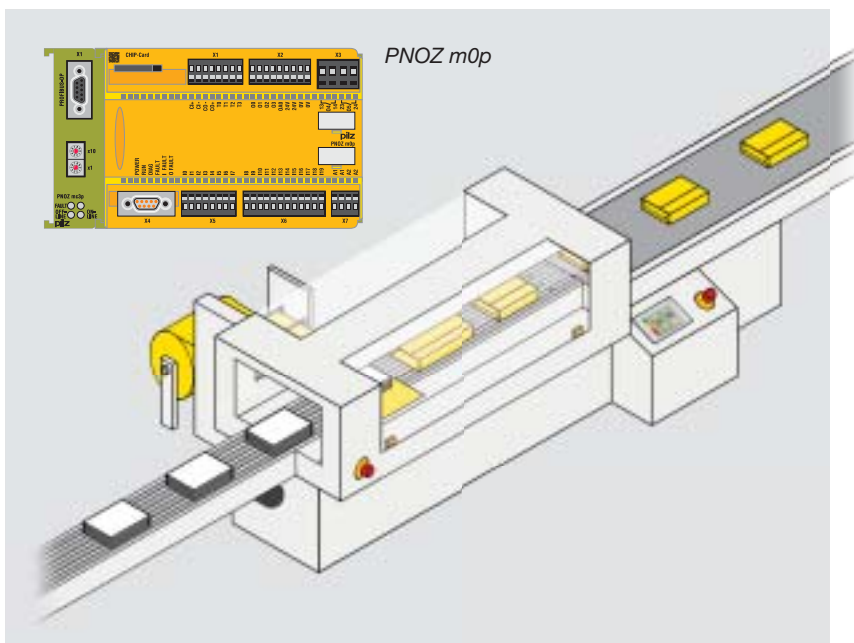

PNOZ m0p

ions – one solution!

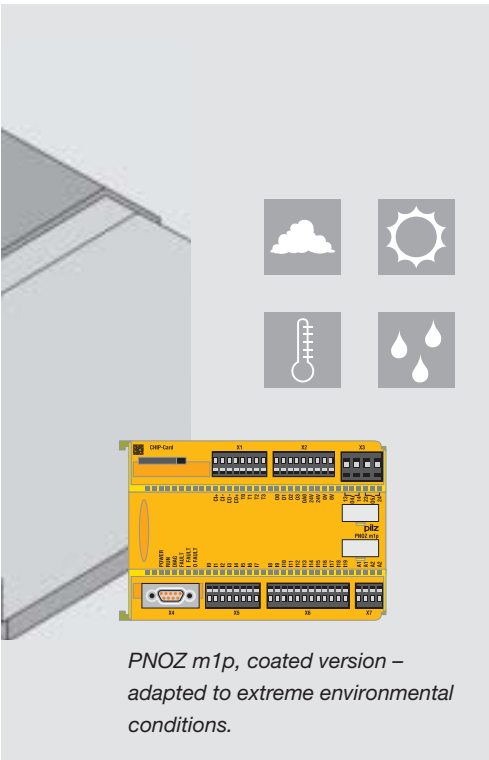

PNOZ m1p, coated version – adapted to extreme environmental conditions.

PNOZ m1p, coated version – Tough ...

... and specially designed for use in a rugged everyday industrial environment, the units' PCB boards are varnished and therefore protected from environmental influences. The benefits include an expanded temperature range, tolerance of condensation and resistance to corrosive gas.

PNOZ m2p – Withstands plenty ...

... and is specially designed to control and monitor small and average-sized eccentric and hydraulic presses. Approved software blocks are available for operating modes such as set-up mode, single-stroke and auto-

matic, and to monitor safety light curtains in single-break or double-break mode; these blocks make the system simple and economical to use. In conjunction with the dual-pole semiconductor output module PNOZ mo3p, the PNOZ m2p can control press safety valves safely and economically.

All base units: 20 inputs, 4 safe semiconductor and 2 relay outputs.

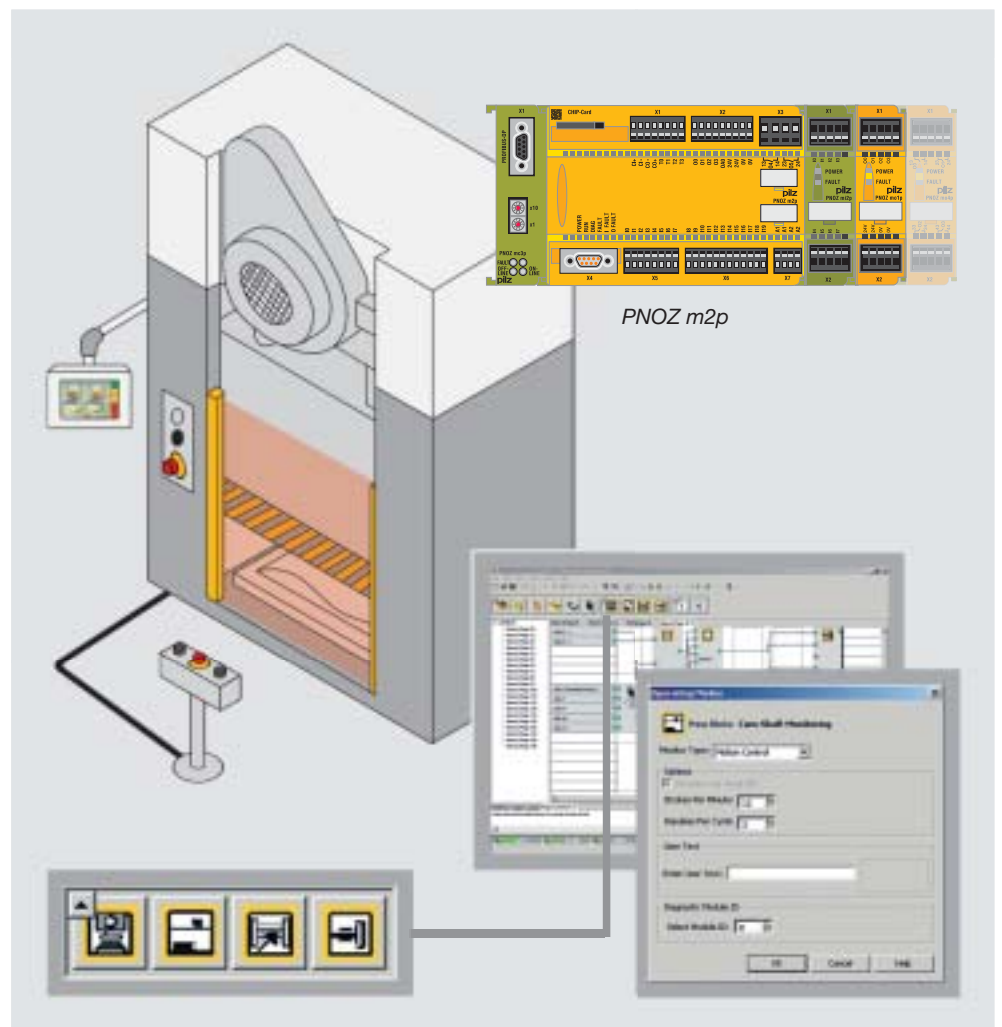

PNOZ m2p



► For increased cost-effectiveness

Monitoring analogue input signals safely

The safe analogue input module PNOZ ma1p provides two independent, safe inputs. Up to eight limit values can be defined for each input with just a few clicks of the mouse in the PNOZmulti Configurator. The inputs are suitable for connecting transducers or encoders with standardised 10 V voltage signals or 20 mA

current signals. As users you benefit from rapid commissioning and reduced wiring. With its analogue input module, the PNOZmulti is particularly suitable for the process engineering sector, as well as for cable car and chair lift design and burner controls.

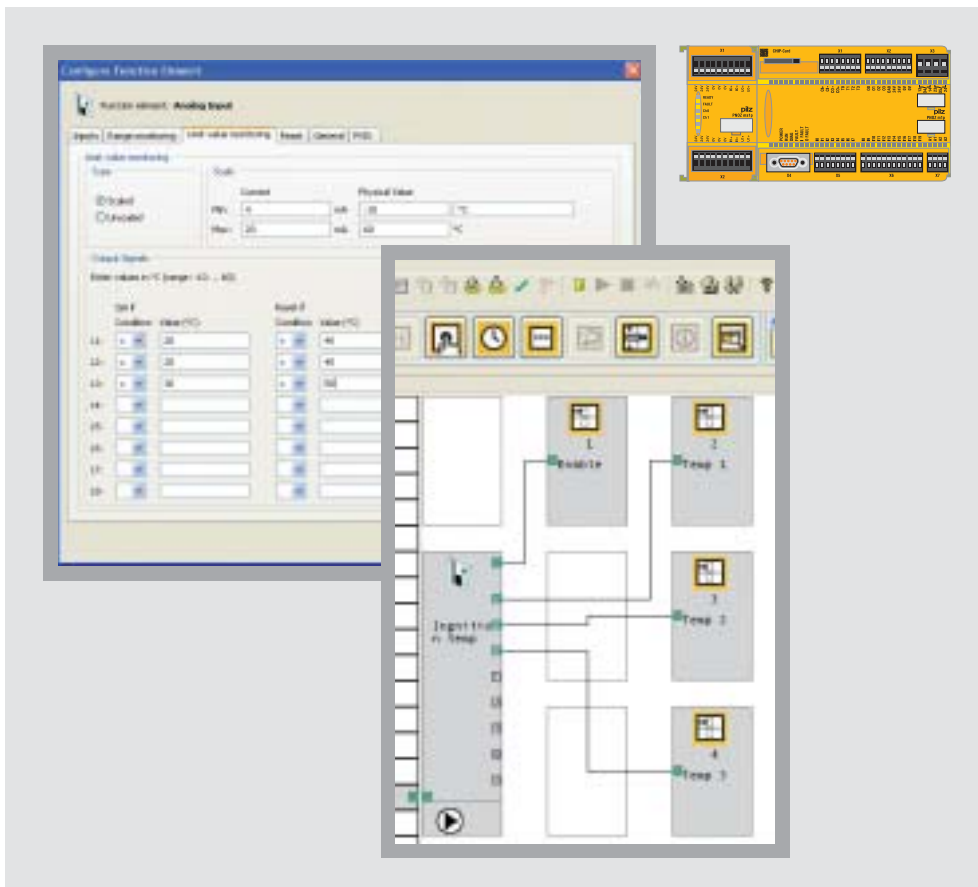

PNOZ ma1p – with two safe analogue inputs.

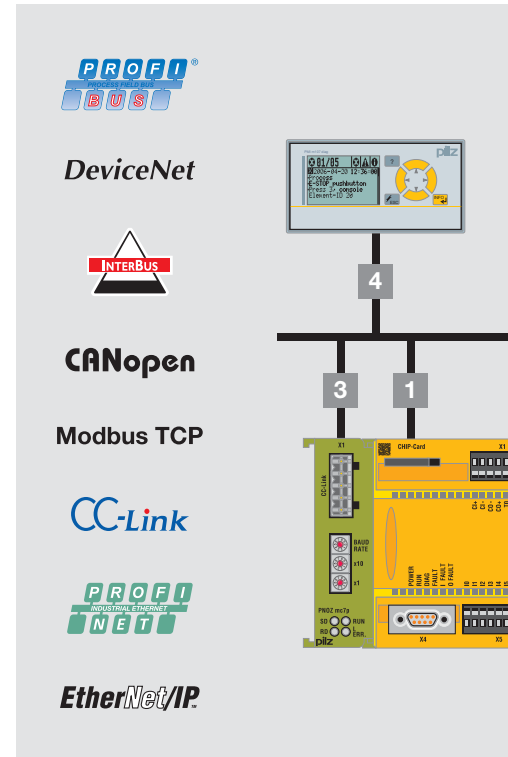

Diagnostics with PNOZmulti – Always in the know

User-friendly diagnostic and control information guarantees short downtimes and high plant availability. With PNOZmulti there are several options for diagnostics:

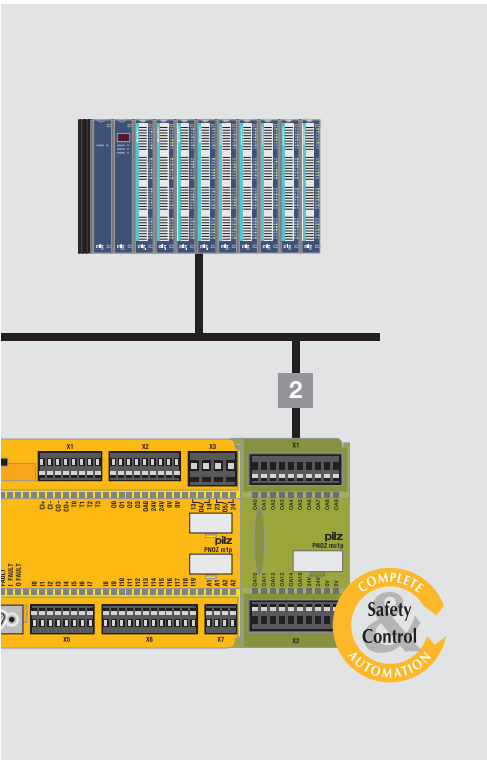

- 1 Serial interface
- 2 Status messages to the PLC: PNOZ mc1p
- 3 Two-way signalling and control: all common fieldbus systems such as PROFIBUS-DP, DeviceNet, Interbus, CANopen or CC-Link
- 4 Diagnostic system PMLmicro diag

Reduce downtimes with PVIS

Thanks to the modern PVIS diagnostic concept, PNOZmulti and PMI operator terminals can provide an overall, integrated diagnostic solution¹⁾. If a fault occurs, features such as plain text messages with precise information on the location, clearly defined responsibilities and integrated first fault display all ensure that production is quickly restarted. The PNOZmulti Configurator contains the



PNOZmulti project, texts for diagnostics, proposed solutions and more. The benefits are obvious: there's less configuration required, greater flexibility and downtimes are reduced.

¹⁾ PNOZ m1p base unit from Version 5, PNOZ m0p and PNOZ m2p base units from Version 2, PNOZmulti Configurator from Version 5.0.0

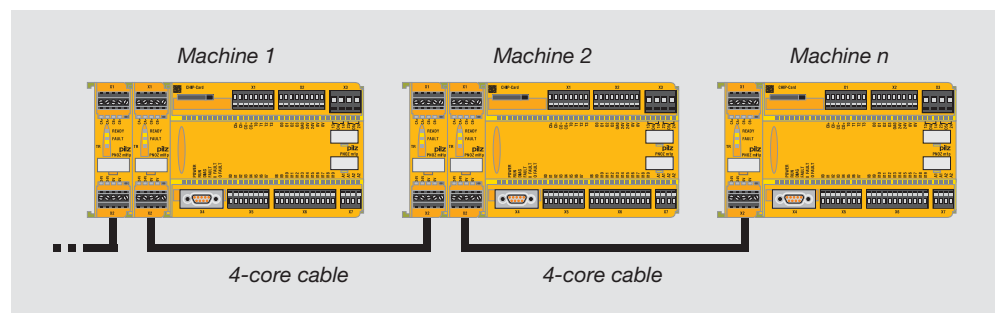

PNOZ ml1p – for the safe connection of PNOZmulti base units.

Even complex tasks can be mastered within a network

The safe connection module PNOZ ml1p enables data to be exchanged simply between several PNOZmulti base units. The benefit: if a unit's physical limits are exhausted, users can employ several PNOZmulti devices, enabling them to monitor and control more complex machinery. Selective shutdown and commissioning of plant sections are also a possibility.

The modular structure of the PNOZmulti enables you to connect up to six PNOZ ml1p connection modules to each base unit, allowing both ring and tree structures to be established. You can quickly and easily allocate the information to be transferred within the PNOZmulti Configurator. No specialist knowledge of safe bus systems is required, nor do the connected devices need to be specifically addressed.

Further information on the PVIS diagnostic concept:

Webcode 1046

Online information at www.pilz.com



▶ Selection guide – PNOZmulti

Configurable control system – PNOZmulti



Type	Scope	Performance Level (PL) ¹⁾ – EN ISO 13849-1	Safety Integrity Level (SIL) CL ¹⁾ – claim limit in accordance with IEC 62061
PNOZ mi1p	Safe input module	e	3
PNOZ mi2p	Input module	e	3
PNOZ ma1p	Safe analogue input module	e	3
PNOZ mo1p	Safe semiconductor output module	e	3
PNOZ mo3p	2-pole, safe semiconductor output module	e	3
PNOZ mo2p	Safe relay output module	e	3
PNOZ mo4p	Safe relay output module	e	3
PNOZ mc1p	Output module	-	-
PNOZ ms1p/ PNOZ ms2p/ PNOZ ms3p	Safe speed/standstill monitoring module	e	3
PNOZ ml1p	Safe connection module	e	3
PNOZ mc3p	PROFIBUS-DP fieldbus module	-	-
PNOZ mc4p	DeviceNet fieldbus module	-	-
PNOZ mc5p	Interbus fieldbus module	-	-
PNOZ mc5.1p	Fieldbus module, Interbus FO	-	-
PNOZ mc0p	Power supply for Interbus fieldbus modules PNOZ mc5p and PNOZ mc5.1p	-	-
PNOZ mc6p	CANopen fieldbus module	-	-
PNOZ mc7p	CC-Link fieldbus module	-	-
PNOZ mc8p	Ethernet/IP/Modbus fieldbus module	-	-
PNOZ mc9p	PROFINET fieldbus module	-	-

Connection of expansion modules to base unit²⁾

PNOZ m0p 3 ... 6 safety functions	PNOZ m1p ≥ 4 safety functions	PNOZ m1p (coated version) ≥ 4 safety functions	PNOZ m2p (press applications) ≥ 4 safety functions
	◆	◆	◆
	◆		◆
	◆		◆
	◆	◆	◆
	◆		◆
	◆	◆	◆
	◆	◆	◆
	◆	◆	◆
	◆		◆
◆	◆		◆
◆	◆		◆
◆	◆	◆	◆
◆	◆		◆
◆	◆		◆
◆	◆		◆
◆	◆	◆	◆
◆	◆	◆	◆
◆	◆		◆
◆	◆		◆

¹⁾ Maximum achievable value, depending on the application, e.g. number of outputs.

²⁾ All base units comply with Performance Level e and Safety Integrity Level 3.

Technical documentation on the PNOZmulti configurable control system:

Webcode 0685

Online information at www.pilz.com



► Technical details – PNOZmulti

Base units – PNOZmulti Controller

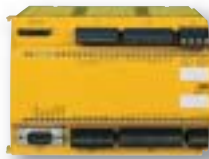

PNOZ m0p

Type	Scope	Application range
PNOZ m0p	Base unit – from 3 ... 6 safety functions Fieldbus modules can be connected; no other expansion modules can be connected	E-STOP, two-hand buttons, safety gate limit switches, light beam devices, scanners, enable switches, PSEN safety gate switch, operating mode selector switches, muting, safety mats, sensors
PNOZ m1p/ PNOZ m1p (coated version)	Base unit – from 4 safety functions and for standard control functions	
PNOZ m2p	Base unit – specifically for press applications	As PNOZ m1p, additional monitoring of operating modes such as set-up mode, single-stroke and automatic, safety light curtains in single-break and double-break mode, camshaft with run monitoring, press safety valves, muting, safety mats, sensors

Input modules – PNOZmulti I/O



PNOZ mi1p

Type	Scope	Inputs/outputs
PNOZ mi1p/ PNOZ mi1p (coated version)	Safe input module	8 safe inputs
PNOZ mi2p	Input module	8 inputs

Common features

- Supply voltage (U_B): 24 VDC via base unit
- Dimensions (H x W x D): 94 x 22.5 x 121 mm

Features	Order number		
		Spring-loaded terminals	Plug-in screw terminals
<ul style="list-style-type: none"> ▶ Configurable using PNOZmulti Configurator via chip card or RS 232 interface ▶ Exchangeable program memory ▶ Diagnostic interface ▶ Fieldbus modules can be connected ▶ PNOZ m1p/PNOZ m2p: Max. 8 expansion modules can be connected ▶ Inputs/outputs: <ul style="list-style-type: none"> - 20 freely configurable inputs, 4 test pulse outputs, 1 auxiliary output - Outputs using semiconductor technology: <ul style="list-style-type: none"> 4 safety outputs - Relay outputs: 2 safety contacts ▶ Supply voltage (U_s): 24 VDC ▶ Voltage/current/rating: <ul style="list-style-type: none"> - Outputs using semiconductor technology: 24 V DC/2 A/48 W - Relay outputs: DC1: 24 V/6 A/144 W ▶ Dimensions (H x W x D): 94 x 135 x 121 mm 	773 110 (without terminals)	783 100 (1 set)	793 100 (1 set)
	<ul style="list-style-type: none"> ▶ 773 100 (without terminals) ▶ 773 105 (coated version, without terminals) 	783 100 (1 set)	793 100 (1 set)
	773 120 (without terminals)	783 100 (1 set)	793 100 (1 set)



Features	Order number		
		Spring-loaded terminals	Plug-in screw terminals
<ul style="list-style-type: none"> ▶ Max. 8 input modules can be connected to the base unit ▶ Connected to base unit using jumpers on the back of the unit 	<ul style="list-style-type: none"> ▶ 773 400 (without terminals) ▶ 773 405 (coated version, without terminals) 	783 400 (1 set)	793 400 (1 set)
<ul style="list-style-type: none"> ▶ Max. 8 input modules can be connected to the base unit ▶ Connected to base unit using jumpers on the back of the unit 	773 410 (without terminals)	783 400 (1 set)	793 400 (1 set)

Technical documentation on the PNOZmulti configurable control system:

Webcode 0685

Online information at www.pitz.com

¹⁾ not for PNOZ mi2p



► Technical details – PNOZmulti



Input modules – PNOZmulti I/O

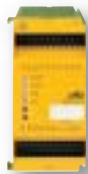

PNOZ ma1p

Type	Scope	Inputs/outputs
PNOZ ma1p	Safe analogue input module	2 analogue inputs for voltage or current measurement (configurable)

Output modules – PNOZmulti I/O



PNOZ mo1p

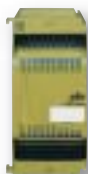

PNOZ mc1p

Type	Scope	Inputs/outputs	Supply voltage
PNOZ mo1p/ PNOZ mo1p (coated version)	Safe semiconductor output module: Switching 24 V actuators	Outputs using semiconductor technology: 4 safety outputs	24 VDC
PNOZ mo3p	Safe semiconductor output module, 2-pole	2-pole outputs using semiconductor technology: 2 safety outputs	24 VDC via expansion module
PNOZ mo2p/ PNOZ mo2p (coated version)	Safe relay output module: Volt-free switching of actuators	Relay outputs: 2 safety outputs	24 VDC via base unit
PNOZ mo4p/ PNOZ mo4p (coated version)	Safe relay output module: Volt-free switching of actuators	Relay outputs: 4 safety outputs	24 VDC via base unit
PNOZ mc1p/ PNOZ mc1p (coated version)	Output module: Status message to PLC	16 auxiliary outputs using semiconductor technology	24 VDC

Common features

- Dimensions (H x W x D): 94 x 22.5 x 121 mm, PNOZ mc1p: 94 x 45 x 121 mm

Features	Order number		
		Spring-loaded terminals	Plug-in screw terminals
<ul style="list-style-type: none"> ▶ Range monitoring (4 range limits can be configured) ▶ Threshold value monitoring (8 limit values can be configured) ▶ Voltage range: -10.24 ... +10.2375 V ▶ Current range: 0 ... 25.59 mA ▶ Installed to the left of the base unit ▶ Max. 4 PNOZ ma1p units can be connected to the base unit ▶ Status indicators ▶ Dimensions (H x W x D): 94 x 45 x 121 mm 	773 812 (without terminals)	783 700 (1 set)	793 700 (1 set)

Outputs: Voltage/current/ rating	Features	Order number		
			Spring-loaded terminals	Plug-in screw terminals
24 VDC/2 A/48 W	<ul style="list-style-type: none"> ▶ Max. 6 semiconductor output modules can be connected to the base unit ▶ Connected to base unit using jumpers on the back of the unit 	<ul style="list-style-type: none"> ▶ 773 500 (without terminals) ▶ 773 505 (coated version, without terminals) 	783 400 (1 set)	793 400 (1 set)
24 VDC/2 A	<ul style="list-style-type: none"> ▶ Max. 6 semiconductor output modules can be connected to the base unit ▶ Connected to base unit using jumpers on the back of the unit 	773 510 (without terminals)	783 400 (1 set)	793 400 (1 set)
DC1: 24 V/6 A	<ul style="list-style-type: none"> ▶ Max. 6 semiconductor output modules can be connected to the base unit ▶ Connected to base unit using jumpers on the back of the unit 	<ul style="list-style-type: none"> ▶ 773 520 (without terminals) ▶ 773 525 (coated version, without terminals) 	783 520 (1 set)	793 520 (1 set)
DC1: 24 V/6 A	<ul style="list-style-type: none"> ▶ Max. 6 semiconductor output modules can be connected to the base unit ▶ Connected to base unit using jumpers on the back of the unit 	<ul style="list-style-type: none"> ▶ 773 536 (without terminals) ▶ 773 537 (coated version, without terminals) 	783 536 (1 set)	793 536 (1 set)
-	<ul style="list-style-type: none"> ▶ Max. 8 output modules can be connected to the base unit ▶ Connected to base unit using jumpers on the back of the unit 	<ul style="list-style-type: none"> ▶ 773 700 (without terminals) ▶ 773 705 (coated version, without terminals) 	783 700 (1 set)	793 700 (1 set)



Technical documentation on the PNOZmulti configurable control system:

 Webcode 0685

Online information at www.pilz.com



► Technical details – PNOZmulti



Monitoring module – PNOZmulti I/O

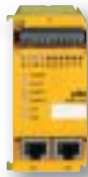

PNOZ ms1p

Type	Scope	Dimensions (H x W x D) in mm
PNOZ ms1p/ PNOZ ms2p/ PNOZ ms3p	Safe speed and standstill monitoring module up to Performance Level (PL) e	94 x 45 x 121

Connection module – PNOZmulti COM



PNOZ ml1p

Type	Scope	Dimensions (H x W x D) in mm
PNOZ ml1p	Connection module: for safe connection of two PNOZmulti base units	94 x 22.5 x 121

Cable – PNOZmulti PAA



PNOZ msi1AP

Type	Scope	Dimensions (H x W x D) in mm
PNOZ msi1AP ... and more	Connection cable for PNOZ ms1p/ PNOZ ms2p/PNOZ ms3p to connect incremental encoders	On request
PNOZ mli1p	Connection cable for the PNOZ ml1p	5 m, 10 m, 50 m

Features	Order number		
		Spring-loaded terminals	Plug-in screw terminals
<ul style="list-style-type: none"> ▶ Supply voltage (U_p): 24 VDC via base unit ▶ Up to 8 limit values can be configured using the PNOZmulti Configurator ▶ Can be evaluated in the PNOZmulti Configurator ▶ Incremental encoders are connected via connection cable ▶ Two axes can be monitored independently ▶ Max. 4 modules can be connected to the base unit ▶ Connected to base unit via plug-in connector on the back of the unit ▶ PNOZ ms1p/PNOZ ms2p: <ul style="list-style-type: none"> - Proximity detectors are connected directly to the terminals ▶ PNOZ ms2p/PNOZ ms3p: <ul style="list-style-type: none"> - Incremental encoder with differential output signals from 0.5 Vss to 30 Vss, i.e. now also suitable for HTL encoders - Independent from the supply voltage of the incremental encoder, i.e. also for encoders with 8 V supply voltage, for example 	<ul style="list-style-type: none"> ▶ PNOZ ms1p 773800 (without terminals) ▶ PNOZ ms2p 773810 (without terminals) ▶ PNOZ ms3p 773820 (without terminals) 	783 800 (1 set)	793 800 (1 set)



Features	Order number		
		Spring-loaded terminals	Plug-in screw terminals
<ul style="list-style-type: none"> ▶ Point-to-point connection via 4-core screened cable ▶ Transfer of 32 bit input data and 32 bit output data ▶ Several PNOZmulti base units can be networked by linking additional connection modules – either in tree or in ring structure 	773 540 (without terminals)	783 400 (1 set)	793 400 (1 set)

Technical documentation on the PNOZmulti configurable control system:

Webcode 0685

Online information at www.pitz.com

Features	Order number		
		Spring-loaded terminals	Plug-in screw terminals
<ul style="list-style-type: none"> ▶ Used to connect an incremental encoder to the speed monitors PNOZ ms1p/PNOZ ms2p/PNOZ ms3p ▶ Connection cable for all common makes of drive ▶ Connection to drive and incremental encoder via 25-pin or 15-pin D-Sub male and female connector, or wired with stranded cable ▶ Variable cable lengths 	<ul style="list-style-type: none"> ▶ PNOZ msi1AP 25/25 Si/Ha, 2.5 m773840 ▶ PNOZ msi5p 15/15 Bo/Rex, 2.5 m773857 ▶ PNOZ msi15p 15/15 PMCtendo, 2.5 m773874 ▶ Other versions available 		
<ul style="list-style-type: none"> ▶ Ready-made as spring-loaded or screw terminal type ▶ Shielded 	<ul style="list-style-type: none"> ▶ 5 m773890 ▶ Additional versions available on request 		



► Technical details – PNOZmulti



DeviceNet



Fieldbus modules – PNOZmulti COM



Type	Scope	Supply voltage (U _B)
PNOZ mc3p	Fieldbus module PROFIBUS-DP	24 VDC via base unit
PNOZ mc4p/ PNOZ mc4p (coated version)	Fieldbus module DeviceNet	24 VDC via base unit
PNOZ mc5p	Fieldbus module Interbus	24 VDC via base unit
PNOZ mc5.1p	Fieldbus module Interbus FO	24 VDC via base unit
PNOZ mc0p	Power supply for fieldbus modules PNOZ mc5p and PNOZ mc5.1p	24 VDC

Dimensions (H x W x D) in mm	Features	Order number
94 x 22.5 x 119	<ul style="list-style-type: none"> ▶ Can be configured using the PNOZmulti Configurator ▶ Station addresses from 0 ... 99, selected via rotary switch ▶ Status indicators via LEDs ▶ Subscriber (Slave) on PROFIBUS-DP ▶ Transmission rate: Max. 12 Mbit/s ▶ Max. 1 fieldbus module can be connected to the base unit ▶ Connected to base unit using jumpers on the back of the unit 	773 721
94 x 22.5 x 122	<ul style="list-style-type: none"> ▶ Can be configured using the PNOZmulti Configurator ▶ Station addresses from 0 ... 63, selected via DIP switch ▶ Status indicators via LEDs ▶ Subscriber (Slave) on DeviceNet ▶ Transmission rate: 125, 250, 500 kbit/s ▶ Max. 1 fieldbus module can be connected to the base unit ▶ Connected to base unit using jumpers on the back of the unit 	<ul style="list-style-type: none"> ▶ 773 722 ▶ 773 729 (coated version)
94 x 22.5 x 119	<ul style="list-style-type: none"> ▶ Can be configured using the PNOZmulti Configurator ▶ Status indicators via LEDs ▶ Subscriber (Slave) on Interbus ▶ Transmission rate selected via jumper ▶ Transmission rate: 500 kbit/s, 2 Mbit/s ▶ Max. 1 fieldbus module can be connected to the base unit ▶ Connected to base unit using jumpers on the back of the unit 	773 723
94 x 22.5 x 121	<ul style="list-style-type: none"> ▶ Can be configured using the PNOZmulti Configurator ▶ Subscriber (Slave) on Interbus with fibre-optic cable ▶ Transmission rate, selectable between 500 kbit/s or 2 Mbit/s ▶ Status indicators for communication with Interbus and for errors ▶ Max. 1 fieldbus module can be connected to the base unit ▶ FSMA connection technology ▶ Connected to base unit using jumpers on the back of the unit 	773 728
94 x 22.5 x 121	<ul style="list-style-type: none"> ▶ Interface to connect the base unit and a fieldbus module ▶ Galvanic isolation ▶ Max. 1 fieldbus module (PNOZ mc5p or PNOZ mc5.1p) can be connected ▶ Status indicators ▶ Plug-in terminals (either with cage clamp terminals or screw connection) ▶ Connected to base unit and fieldbus module using jumpers on the back of the unit 	<ul style="list-style-type: none"> ▶ 773 720 ▶ Spring-loaded terminals (1 set) 783 400 ▶ Plug-in screw terminals (1 set) 793 400



Technical documentation on the PNOZmulti configurable control system:

Webcode 0685

Online information at www.pilz.com



► Technical details – PNOZmulti



Fieldbus modules – PNOZmulti COM

CANopen



PNOZ mc6p

CC-Link



PNOZ mc7p

EtherNet/IP

Modbus TCP



PNOZ mc8p

PROFINET



PNOZ mc9p

Type	Scope	Supply voltage (U _B)
PNOZ mc6p	Fieldbus module CANopen	24 VDC via base unit
PNOZ mc7p	Fieldbus module CC-Link	24 VDC via base unit
PNOZ mc8p	Fieldbus module Ethernet/IP, Modbus TCP	24 VDC via base unit
PNOZ mc9p	Fieldbus module PROFINET IO Device	24 VDC via base unit

Dimensions (H x W x D) in mm	Features	Order number
94 x 22.5 x 122	<ul style="list-style-type: none"> ▶ Can be configured using the PNOZmulti Configurator ▶ Station addresses from 0 ... 99, selected via rotary switch ▶ Status indicators via LEDs ▶ Subscriber (Slave) on CANopen ▶ Transmission rate selected via rotary switch ▶ Transmission rate: Max. 1 Mbit/s ▶ Max. 1 fieldbus module can be connected to the base unit ▶ Connected to base unit using jumpers on the back of the unit 	<ul style="list-style-type: none"> ▶ 773 724 ▶ 773 727 (coated version)
94 x 22.5 x 122	<ul style="list-style-type: none"> ▶ Can be configured using the PNOZmulti Configurator ▶ Station addresses from 1 ... 63, selected via rotary switch ▶ Status indicators via LEDs ▶ Subscriber (Slave) on CC-Link ▶ Occupied stations: 2 ▶ Transmission rate selected via rotary switch ▶ Transmission rate: Max. 10 Mbit/s ▶ Max. 1 fieldbus module can be connected to the base unit ▶ Connected to base unit using jumpers on the back of the unit 	<ul style="list-style-type: none"> ▶ 773 726 ▶ 773 725 (coated version)
94 x 22.5 x 114	<ul style="list-style-type: none"> ▶ Can be configured in the PNOZmulti Configurator ▶ Subscriber on Ethernet/IP (Adapter) or Modbus TCP (Slave) ▶ Transmission rate 10 Mbit/s ▶ Status indicators via LEDs ▶ IP address is set via DIP switches on the front of the unit ▶ Max. 1 fieldbus module can be connected to the base unit ▶ Connected to base unit using jumpers on the back of the unit 	773 730
94 x 22.5 x 114	<ul style="list-style-type: none"> ▶ Device name can be configured in the PNOZmulti Configurator ▶ Subscriber on PROFINET IO (PROFINET IO Device) ▶ Diagnostics and alarm functions are not supported ▶ Status indicators via LEDs ▶ Max. 1 fieldbus module can be connected to the base unit ▶ Connected to base unit using jumpers on the back of the unit 	773 731



Technical documentation on the PNOZmulti configurable control system:

Webcode 0685

Online information at www.pitz.com



► Technical details – PNOZmulti

Software – PNOZmulti PASsystem



Type	Features
PNOZmulti Configurator	<ul style="list-style-type: none"> ▶ Graphic tool for configuration and programming of the PNOZmulti configurable control system ▶ Project configuration, configuration generation, documentation, commissioning ▶ Data transfer via serial interface or chip card ▶ User interface in German, English, French, Italian, Spanish, Japanese, Chinese (selectable)

Accessories – PNOZmulti IS



Type	Features
PNOZmulti Tool Kit	<ul style="list-style-type: none"> ▶ The Tool Kit contains the accessories you need to start working with PNOZmulti: <ul style="list-style-type: none"> - Documentation folder with the PNOZmulti Configurator - Chip card reader to write and save the configuration on to a chip card - Chip card set consisting of 10 chip cards, including a chip card adapter for rewriting chips removed from the chip card - Configuration cable for reading diagnostic data



System requirements	Order number
<ul style="list-style-type: none"> ▶ Operating system: Windows® 2000, XP or Vista ▶ Standard PC with min. 1 GHz processor ▶ RAM: min. 1 024 Mbyte ▶ Hard drive: 20 Gbyte, min. 15 Gbyte of available disk space ▶ Supports Super VGA graphics ▶ CD-ROM drive 	<p>CD-ROM and documentation folder¹⁾.....773 000</p> <p>CD-ROM¹⁾.....773 000D</p> <p>Full version for configuration</p> <ul style="list-style-type: none"> ▶ Single-user licence (Basic)773 010B ▶ Additional licence (User).....773 010K ▶ Upgrade licence (Basic).....773 010U ▶ Time restricted single-user licence (Basic), 2 months.....773 010S ▶ Time restricted single-user licence (Basic), 3 months.....773 010R ▶ Time restricted single-user licence (Basic), 4 months.....773 010Q <p>Service version for diagnostics during service and maintenance</p> <ul style="list-style-type: none"> ▶ Single-user licence (Basic)773 011B ▶ Additional licence (User).....773 011K ▶ Upgrade licence (Basic).....773 011U

¹⁾ Please order licence separately; this is required in order to activate the software; other licence types available on request

Order number					
PNOZmulti Tool Kit	Chip card reader	Chip card set	Configuration cable	Documentation folder with PNOZmulti Configurator	Licence type
779 000	779 230 ²⁾	<ul style="list-style-type: none"> ▶ 8 kbyte.....779 200²⁾ ▶ 32 kbyte.....779 212²⁾ 	310 300 ²⁾	773 000 Please order licence separately	773 010... compare PNOZmulti Configurator

Technical documentation on the PNOZmulti configurable control system:

Webcode 0685

Online information at www.pilz.com

²⁾ For use only with subsequent orders

▶ AT

Pilz Ges.m.b.H.
Sichere Automation
Modcenterstraße 14
1030 Wien
Austria
Telephone: +43 1 7986263-0
Telefax: +43 1 7986264
E-Mail: pilz@pilz.at

▶ AU

Pilz Australia
Safe Automation
Suite C1, 756 Blackburn Road
Clayton, Melbourne VIC 3168
Australia
Telephone: +61 3 95446300
Telefax: +61 3 95446311
E-Mail: safety@pilz.com.au

▶ BE ▶ LU

Pilz Belgium
Safe Automation
Bijenstraat 4
9051 Gent (Sint-Denijs-Westrem)
Belgium
Telephone: +32 9 3217570
Telefax: +32 9 3217571
E-Mail: info@pilz.be

▶ BR

Pilz do Brasil
Automação Segura
Rua Ártico, 123 - Jd. do Mar
09726-300
São Bernardo do Campo - SP
Brazil
Telephone: +55 11 4337-1241
Telefax: +55 11 4337-1242
E-Mail: pilz@pilz.com.br

▶ CH

Pilz Industrieelektronik GmbH
Gewerbepark Hintermättli
Postfach 6
5506 Mägenwil
Switzerland
Telephone: +41 62 88979-30
Telefax: +41 62 88979-40
E-Mail: pilz@pilz.ch

▶ CN

Pilz Industrial Automation
Trading (Shanghai) Co., Ltd.
Safe Automation
Rm. 704-706
No. 457 Wu Lu Mu Qi (N) Road
Shanghai 200040
China
Telephone: +86 21 62494658
Telefax: +86 21 62491300
E-Mail: sales@pilz.com.cn

▶ DE

Pilz GmbH & Co. KG
Felix-Wankel-Straße 2
73760 Ostfildern
Germany
Telephone: +49 711 3409-0
Telefax: +49 711 3409-133
E-Mail: pilz.gmbh@pilz.de

▶ DK

Pilz Skandinavien K/S
Safe Automation
Ellegaardvej 25 L
6400 Sonderborg
Denmark
Telephone: +45 74436332
Telefax: +45 74436342
E-Mail: pilz@pilz.dk

▶ ES

Pilz Industrieelektronik S.L.
Safe Automation
Camí Ral, 130
Polígono Industrial Palou Nord
08400 Granollers
Spain
Telephone: +34 938497433
Telefax: +34 938497544
E-Mail: pilz@pilz.es

▶ FI

Pilz Skandinavien K/S
Safe Automation
Nuijamiestentie 5 A
00400 Helsinki
Finland
Telephone: +358 9 27093700
Telefax: +358 9 27093709
E-Mail: pilz.fi@pilz.dk

▶ FR

Pilz France Electronic
1, rue Jacob Mayer
BP 12
67037 Strasbourg Cedex 2
France
Telephone: +33 3 88104000
Telefax: +33 3 88108000
E-Mail: siege@pilz-france.fr

▶ GB

Pilz Automation Technology
Safe Automation
Willow House, Medicott Close
Oakley Hay Business Park
Corby
Northants NN18 9NF
United Kingdom
Telephone: +44 1536 460766
Telefax: +44 1536 460866
E-Mail: sales@pilz.co.uk

▶ IE

Pilz Ireland Industrial Automation
Cork Business and Technology Park
Model Farm Road
Cork
Ireland
Telephone: +353 21 4346535
Telefax: +353 21 4804994
E-Mail: sales@pilz.ie

▶ IT

Pilz Italia Srl
Automazione sicura
Via Meda 2/A
22060 Novedrate (CO)
Italy
Telephone: +39 031 789511
Telefax: +39 031 789555
E-Mail: info@pilz.it

▶ JP

Pilz Japan Co., Ltd.
Safe Automation
Shin-Yokohama Fujika Building 5F
2-5-9 Shin-Yokohama
Kohoku-ku
Yokohama 222-0033
Japan
Telephone: +81 45 471-2281
Telefax: +81 45 471-2283
E-Mail: pilz@pilz.co.jp

▶ KR

Pilz Korea Ltd.
Safe Automation
9F Jo-Yang Bld. 50-10
Chungmuro2-Ga Jung-Gu
100-861 Seoul
Republic of Korea
Telephone: +82 2 2263 9541
Telefax: +82 2 2263 9542
E-Mail: info@pilzkorea.co.kr

▶ MX

Pilz de México, S. de R.L. de C.V.
Automatización Segura
Circuito Pintores 170
Cd. Satélite
Naucalpan, Méx. 53100
Mexico
Telephone: +52 55 5572 1300
Telefax: +52 55 5572 1300
E-Mail: info@mx.pilz.com

▶ NL

Pilz Nederland
Veilige automatisering
Postbus 186
4130 ED Vianen
Netherlands
Telephone: +31 347 320477
Telefax: +31 347 320485
E-Mail: info@pilz.nl

▶ ...

In many countries we are represented by sales partners.

Please refer to our homepage for further details or contact our headquarters.

▶ NZ

Pilz New Zealand
Safe Automation
5 Nixon Road
Mangere
Auckland
New Zealand
Telephone: +64 9 6345350
Telefax: +64 9 6345352
E-Mail: t.catterson@pilz.co.nz

▶ PL

Pilz Polska Sp. z o.o.
Safe Automation
ul. Odlewnicza 1
03-231 Warszawa
Poland
Telephone: +48 22 8847100
Telefax: +48 22 8847109
E-Mail: info@pilz.pl

▶ PT

Pilz Industrieelektronik S.L.
R. Eng Duarte Pacheco, 120
4 Andar Sala 21
4470-174 Maia
Portugal
Telephone: +351 229407594
Telefax: +351 229407595
E-Mail: pilz@pilz.es

▶ SE

Pilz Skandinavien K/S
Safe Automation
Enerigatan 10 B
43437 Kungsbacka
Sweden
Telephone: +46 300 13990
Telefax: +46 300 30740
E-Mail: pilz.se@pilz.dk

▶ TR

Pilz Emniyet Otomasyon
Ürünleri ve Hizmetleri Tic. Ltd. Şti.
Kayışdağı Cad. Beykonağı Plaza
No:130 K:2 D:2
Kayışdağı-Istanbul
Turkey
Telephone: +90 216 5775550
Telefax: +90 216 5775549
E-Mail: pilz.tr@pilz.de

▶ US ▶ CA

Pilz Automation Safety L.P.
7150 Commerce Boulevard
Canton
Michigan 48187
USA
Telephone: +1 734 354 0272
Telefax: +1 734 354 3355
E-Mail: info@pilzusa.com

▶ www

www.pilz.com

▶ Technical support

+49 711 3409-444



Pilz GmbH & Co. KG
Felix-Wankel-Straße 2
73760 Ostfildern, Germany
Telephone: +49 711 3409-0
Telefax: +49 711 3409-133
E-Mail: pilz.gmbh@pilz.de

pilz